

STIHL

For further information and advice visit:

2024 GAS PRODUCT CATALOGUE

COMMITTED TO TRADITION

For us a family business now in its third generation, long-range thinking is a tradition. It is the prerequisite for creating something substantial and valuable – in short: quality – and passing it on to the next generation. It is also fundamental in providing you, our customer, tangible improvements through innovation and technical leadership with every new development that targets superior performance and user-friendliness.

This tradition is at the heart of every single one of our products. Everything is designed so that a STIHL product can become an heirloom: the raw materials, the technical construction, the design, and the production. Another prerequisite, and the one of paramount importance to us, is the long-term serviceability of our products. Through long-term spare parts reliability, we enable STIHL Dealers to restore our products to the top condition that you, our customer, require to master your tasks.

For us, this is "STIHL quality." It is sustainability in the best sense. Because durable, repairable products conserve our resources in the best possible way. And this is becoming increasingly important – for you as a customer and for us as a company.

In this sense, quality, innovation and sustainability go hand in hand and have been a tradition of the Stihl family for nearly 100 years.

Your Stihl family

Selina Stihl
Stellv. Beiratsvorsitzende –
Deputy Chair of the
Advisory Board

Karen Tebar
Stellv. Beiratsvorsitzende –
Deputy Chair of the
Advisory Board

Dr Nikolas Stihl
Beiratsvorsitzender –
Chair of the
Advisory Board

TECHNICAL EQUIPMENT

ABBREVIATIONS FOR SPECIAL AND DELUXE EQUIPMENT THAT MIGHT BE IN A 'C' (COMFORT) VERSION:

B = Quick Chain Adjuster

The chain can be tensioned entirely without tools, via a small dial, after releasing the sprocket cover.

E = Easy2Start™

Permits convenient, jerk-free starting due to an additional spring between the crankshaft and rope rotor.

M = STIHL M-Tronic™

The carburetor is electronically controlled eliminating the need for carburetor adjustments due to climate or elevation changes. This system will automatically adjust to the operating demands of the machine in all operating conditions ensuring a properly tuned carburetor at all times. STIHL M-Tronic™ provides easier starting, optimum performance, power and fuel savings.

Q = STIHL Quickstop® Super Chain Brake

ABBREVIATIONS FOR SPECIAL FEATURES

F = Electric start

i = Fuel injection

K = Short shaft

R = Wrap (MS)/Loop handle (FS)/Cutter blade (HS)

T = Top handle (MS)/Trimmer blade (HS)

V = Heated carburetor

W = Heated handle

X = Lightweight version



All STIHL products are in compliance with the Canadian Environmental Protection Act.

STIHL COOPERATES WITH THESE CANADIAN INSTITUTIONS:

 Underwriters' Laboratories of Canada

 Canadian Standards Association

General Notice

1. This catalogue is valid as of January 1, 2024.
2. This catalogue renders all previous catalogues invalid.
3. No claims can be made based on the specifications and images in this catalogue. The design, technology, colours and features are subject to change without prior notice.
4. This catalogue presents the comprehensive range of chain saws, power tools, accessories and protective apparel, including new product developments.
5. The brief descriptions and recommended uses of the various products provide a quick overview of the complete range, while the technical specifications help to find the machine that meets your needs.
6. Although the STIHL range shown in this catalogue is in line with the market requirements for Canada, STIHL Limited is not responsible for any model or product specifications that might change throughout the year. Some products may not be exactly as shown in the photos.
7. This catalogue and all its contents are copyright protected. All rights are reserved, particularly alteration, translation and reproduction with electronic systems.

This catalogue contains numerous combinations of tools and accessories designed for different applications and different kinds of users. For normal applications, we endorse the use of STIHL recommended combinations. These can be found in your operator's manual. STIHL Dealers can provide you with individual advice regarding the best combination to suit your needs.

STIHL products are regularly tested by German and international institutions. STIHL participates in these tests and inspections because they are considered to be the logical continuation of STIHL's own test programs and because STIHL attaches great importance to the findings of these independent institutions – particularly in the interests of STIHL customers. These institutions award test marks confirming the high quality and exemplary safety standards of STIHL products.

For more details, visit www.stihl.ca

CONTENTS



INTRODUCTION

1 ZERO-TURN LAWN MOWERS & GAS LAWN MOWERS
FROM PAGE 6

2 CHAIN SAWS AND POLE PRUNERS
FROM PAGE 14

3 CUTTING ATTACHMENTS
FROM PAGE 40

4 TRIMMERS, BRUSHCUTTERS & CLEARING SAWS
FROM PAGE 50

5 KOMBISYSTEM & YARD BOSS®
FROM PAGE 68

6 HEDGE TRIMMERS & LONG REACH HEDGE TRIMMERS
FROM PAGE 80

7 BLOWERS, VACUUM SHREDDERS & SPRAYERS
FROM PAGE 86

8 PRESSURE WASHERS
FROM PAGE 96

9 CONSTRUCTION EQUIPMENT
FROM PAGE 102

10 PROTECTIVE APPAREL
FROM PAGE 114

11 ACCESSORIES
FROM PAGE 134

ZERO IN ON STIHL.

8" CONSUMER ZERO-TURN LAWN MOWERS

12" GAS LAWN MOWERS

10" PROFESSIONAL ZERO-TURN LAWN MOWERS



CONSUMER MODELS

The consumer models of STIHL Zero-Turn mowers give homeowners the power and performance they need to pursue perfection in their own backyards.



NEW
RZ 142

This powerful zero-turn mower features a 23 hp V-Twin engine and a 42" mowing deck.

SPECIFICATIONS	
MOWER DECK	42"
CUTTING HEIGHT	1.5" - 4.5"
HORSEPOWER	23 HP
MAX FORWARD SPEED	10 KM/H



NEW
RZ 152

This consumer model features a four-wheel suspension, 52" commercial-grade deck and a powerful 25 hp V-Twin engine.

SPECIFICATIONS	
MOWER DECK	52"
CUTTING HEIGHT	1.5" - 4.5"
HORSEPOWER	25 HP
MAX FORWARD SPEED	12 KM/H



DELUXE SEATING

Enjoy a comfortable ride throughout the entire job.



NEW
RZ 261

Four-wheel suspension, 25 hp V-Twin engine and a 61" deck make this ideal for homeowners with large properties.

SPECIFICATIONS	
MOWER DECK	61"
CUTTING HEIGHT	1.5" - 4.5"
HORSEPOWER	25 HP
MAX FORWARD SPEED	13 KM/H



BRIGGS & STRATTON® ENGINE

Delivering plenty of power for a consistent, efficient cut.

PROFESSIONAL MODELS

When it comes to professional-grade outdoor power equipment, STIHL has a long history of tools that combine innovative engineering and durable construction. Our zero-turn mowers are no exception. Designed to deliver efficient operation, smooth cuts, durable components, and a comfortable ride, STIHL zero-turn mowers give professionals the best of all worlds.



NEW
RZ 500 K SERIES

Ideal for farm and ranch users or pros, the STIHL RZ 500 Series comes in 52" or 60" decks and combines comfort with performance.

SPECIFICATIONS	
MOWER DECK	52" & 62"
CUTTING HEIGHT	1.5" - 5"
HORSEPOWER	24 HP
MAX FORWARD SPEED	16 KM/H



NEW
RZ 700i K SERIES

Available with a 52" or 60" cutting deck and professional-grade EFI engines, the STIHL RZ 700 Series helps professionals maximize the mowing experience.

SPECIFICATIONS	
MOWER DECK	52" & 62"
CUTTING HEIGHT	1.5" - 5"
HORSEPOWER	26 HP
MAX FORWARD SPEED	16 KM/H

2-BELT PULLEY SYSTEM

The two-belt pulley system provides less stress on each belt, allowing the mower belts to run cooler, enabling a longer lifespan and less maintenance.



INDEPENDENT FRONT SUSPENSION

The independent front suspension with upper and lower control arms offers professionals optimal ride quality.



KAWASAKI ENGINE

Delivering the right power for optimal cut performance.

	Engine	Displacement (CC)	Transaxle model	Max. forward speed (KM/H)	Weight (LB)	Deck size (IN)	Blades	Cutting height (IN)	Roll over protection (ROPS)	Pivoting axle	Front suspension with shocks	Rear suspension with shocks	Armrests	LED Headlight	Dual USB-A 2.0 charger
CONSUMER MODELS															
RZ 142	Briggs & Stratton	724	ZT2200	10	563	42	2	1.5-4.5	-	-	-	-	o	o	o
RZ 152	Briggs & Stratton	732	ZT2800	12	732	52	3	1.5-4.5	-	•	-	•	o	o	•
RZ 261	Briggs & Stratton	724	ZT3100	13	965	61	3	1.5-4.5	-	•	-	•	o	o	•
PROFESSIONAL MODELS															
RZ 552 K	Kawasaki	726	ZT3400	16	1,119	52	3	1.5-5	•	-	•	•	•	•	•
RZ 560 K	Kawasaki	726	ZT3400	16	1,197	60	3	1.5-5	•	-	•	•	•	•	•
RZ 752i K	Kawasaki EFI	726	ZT4400	16	1,319	52	3	1.5-5	•	-	•	•	•	•	•
RZ 760i K	Kawasaki EFI	726	ZT4400	16	1,398	60	3	1.5-5	•	-	•	•	•	•	•

GAS LAWN MOWERS

- For challenging mowing applications in your grounds at home and for agricultural use
- For large areas of lawn
- Housing made from durable aluminium
- With 3-in-1 function for cutting, mulching and catching
- Powerful engines



NEW
RM 655 V

21" • 1" • 3.3" • 101.4 lb ①

The RM 655 V gives homeowners the performance they expect from STIHL and the cut they desire with a 21" aluminum mowing deck, Vario drive, and a mono-comfort ergonomic handlebar.



NEW
RM 655 YS

21" • 1" • 3.3" • 123.5 lb ①

With hydrostatic drive and a blade brake clutch, the RM 655 YS allows for the flexibility to mow at varying speeds to achieve a manicured lawn.



NEW
RM 756 YC

22" • 1" • 3.5" • 134.5 lb ①

The RM 756 YC provides users with a powerful Kohler CV 200 engine and a magnesium mowing deck to efficiently tackle larger jobs.



NEW
RM 655 VS

21" • 1" • 3.3" • 101.4 lb ①

With features like Vario drive and a blade braking clutch, the RM 655 VS allows professionals to efficiently mow lawns.

	Deck width (IN)	Weight (LB) ①	Cutting height (IN)	Grass catcher box (L)	Drive	Mulch Function	Central height adjustment	Mono handle	Side discharge	Self-propelled	Break clutch
--	-----------------	---------------	---------------------	-----------------------	-------	----------------	---------------------------	-------------	----------------	----------------	--------------

CONSUMER MODELS											
RM 655 V	21	101.4	1-3.4	70	Vario	●	●	●	-	●	-
RM 655 VS	21	101.4	1-3.4	70	Vario	●	●	●	-	●	●
RM 655 YS	21	123.5	1-3.4	70	Hydro-static	●	●	●	-	●	●
RM 756 YC	22	134.5	1-3.4	95	Hydro-static	●	-	●	-	●	-

① WEIGHT WITHOUT FUEL.



LEGENDARY STRENGTH.

16 CHAIN SAWS FOR PROPERTY
MAINTENANCE

20 CHAIN SAWS FOR FARMING &
LANDSCAPING

22 CHAIN SAWS FOR FORESTRY

30 RESCUE CHAIN SAWS

32 ARBORIST CHAIN SAWS

34 POLE PRUNERS

36 OVERVIEW OF
CHAIN SAWS &
POLE PRUNERS

CHAIN SAWS FOR PROPERTY MAINTENANCE

The STIHL line of occasional use, gas-powered chain saws fits the bill perfectly for the serious homeowner who prefers the quality features of a professional saw. Comfortable lightweight design, easy starting and excellent power, turn tasks such as cutting and trimming small trees into a breeze.



NEW MS 162

30.1 cc • 1.2 kW • 9.9 lb ②

Entry-level chain saw, the MS 162 is ideal for small projects and occasional use. The lightweight and maneuverable MS 162 features an anti-vibration system and reduced exhaust emission for increased operator comfort.



NEW MS 172 C-E

31.8 cc • 1.4 kW • 10.4 lb ②

Powerful, lightweight chain saw, equipped with STIHL Easy2Start. The MS 172 C-E is equipped with a convenient single-lever control to enable all function, such as start, run and stop, to be operated with just one hand. It's an optimal tool for homeowners looking to take on woodcutting tasks around the home.

② DRY, WITHOUT GUIDE BAR AND CHAIN.

Note: STIHL recommends the use of fuel with no more than 10% Ethanol content. Using fuel with greater than 10% Ethanol content may cause damage to your equipment and may void your STIHL warranty.



NEW MS 182

35.8 cc • 1.6 kW • 10.1 lb ②

The MS 182 is a powerful, easy-to-use homeowner chain saw with a side-mounted chain tensioning for easy and safe re-tensioning of the saw chain and an anti-vibration system to reduce user fatigue while tackling jobs around the home.



NEW MS 212

38.6 cc • 1.8 kW • 10.1 lb ②

The MS 212 features the STIHL 2-MIX engine, anti-vibration system, side-mounted chain tensioning, combi-lever with stop function and single-lever control for easy, convenient handling of the chain saw.

IMPORTANT INFORMATION

WARNING: Improper use of any power tool may cause serious or fatal injury. Read, understand and follow carefully the operating and safety instructions in your operator's manual before using these products.





MS 250

45.4 cc • 2.3 kW • 10.1 lb ②

This model has an excellent power-to-weight ratio. Standard features include a side-access chain tensioner for easy chain adjustment, STIHL Quickstop® inertia chain brake, Master Control Lever™ and anti-vibration system.



MS 250 C-BE

45.4 cc • 2.3 kW • 10.8 lb ②

Easy2Start™

Homeowners will be pleased with the performance and reliability of the gas-powered MS 250 C-BE chain saw. With all of the great features of the MS 250, but includes the STIHL Easy2Start™ System.



MS 251

45.6 cc • 2.2 kW • 10.8 lb ②

Powered by a low-emission and fuel-efficient stratified scavenging engine, it features the STIHL Quickstop® inertia chain brake, Master Control Lever™, anti-vibration system, carburetor preheat shutter for summer/winter operation, tool-less fuel and oil caps with retainers and a high power-to-weight ratio.



MS 251 C-BE

45.6 cc • 2.2 kW • 11.5 lb ②

Easy2Start™

This mid-sized unit is powered by a low-emission and fuel-efficient stratified scavenging engine. It comes equipped with the Easy2Start™ system that will help you start your saw effortlessly, plus a Quick Chain Adjuster for tool-free chain adjusting.

IMPORTANT INFORMATION

WARNING: Improper use of any power tool may cause serious or fatal injury. Read, understand and follow carefully the operating and safety instructions in your operator's manual before using these products.



CHAIN SAWS FOR FARMING & LANDSCAPING

These STIHL chain saws are perfect for all-around use in agriculture and landscaping. Whether building with wood, cutting firewood or for ongoing maintenance, the full range of jobs can be carried out effectively with these powerful chain saws.



MS 271

50.2 cc • 2.6 kW • 12.3 lb ②

Durable chain saw for all-around use, the STIHL MS 271 features up to 20% lower fuel consumption and reduced exhaust emissions. A true powerhouse, this saw takes charge when it comes time for felling, cutting firewood or storm cleanup.



QUICK CHAIN ADJUSTER (B)

STIHL's tool-less Quick Chain Adjuster allows you to put the correct amount of tension on a saw chain without using tools. Available as an add-on for many STIHL models. Ask your dealer about this time-saving feature.



MS 291

55.5 cc • 2.8 kW • 12.3 lb ②

The MS 291 chain saw is an all-around reliable unit for farmers, landscapers and gardeners. Powered by STIHL's fuel-efficient, low-emission stratified scavenging engine technology, which reduces fuel consumption by up to 20%. This saw includes an advanced anti-vibration system and lightweight muffler to reduce operator fatigue. Part of STIHL's new generation of fuel-efficient, environmentally friendly chain saws.



MS 291 C-BE

55.5 cc • 2.8 kW • 13.7 lb ②



The MS 291 C-BE shares similar features with the MS 291 plus a Quick Chain Adjuster, fuel primer and the Easy2Start™ system for effortless starting.

IMPORTANT INFORMATION

WARNING: Improper use of any power tool may cause serious or fatal injury. Read, understand and follow carefully the operating and safety instructions in your operator's manual before using these products.

CHAIN SAWS FOR FORESTRY

These STIHL chain saws are perfect for all users. Powerful professional STIHL chain saws are designed for heavy-duty cutting in extreme conditions. High engine power and relatively low-weight make them ideal for use in dense stands, as well as for cutting hard wood.



MS 261 C-M

50.2 cc • 3.0 kW • 10.8 lb ②

The STIHL MS 261 C-M chain saw is designed for professional use in forestry. Compact, powerful and fitted with the STIHL M-Tronic™ fully electronic engine management system, the MS 261 C-M delivers optimal engine performance at all times, proving its worth when trimming branches, harvesting small diameter wood and felling trees.

Additional versions: MS 261 C-M VW.



MS 261 C-M VW

50.2 cc • 3.0 kW • 11.0 lb ②

The MS 261 C-M VW STIHL Arctic™ model shares similar features with the MS 261 C-M, however it comes equipped with the STIHL Arctic™ system featuring heated handles and carburetor. This unit will perform in all weather conditions from hot to cold weather.

IMPORTANT INFORMATION

WARNING: Improper use of any power tool may cause serious or fatal injury. Read, understand and follow carefully the operating and safety instructions in your operator's manual before using these products.

② DRY, WITHOUT GUIDE BAR AND CHAIN.



MS 391

64.1 cc • 3.3 kW • 13.7 lb ②

The MS 391 is designed for rugged farm use, and landscapers. Not only are the emissions reduced by 70%, this powerful saw uses up to 20% less fuel than a conventional 2-stroke engine. This saw also includes an advanced anti-vibration system and is equipped with a long life air filter system.



SIDE-ACCESS CHAIN TENSIONER

The side-access chain tensioner allows chain tension adjustment through the sprocket cover. The operator's hand never comes close to the chain, making it safe and easy to adjust.





STIHL M-TRONIC™ (M)

This fully electronic engine management system adjusts ignition timing and fuel metering in all operating modes. It also takes external conditions such as temperature, altitude and fuel quality into account. It ensures consistent engine performance, a constant maximum speed and superb acceleration. STIHL M-Tronic™ makes manual carburetor adjustments unnecessary. Thanks to electronic cold/warm start recognition, now there is only one start position on the Master Control Lever™. You need fewer pulls to start and can immediately accelerate up to speed - even after a cold start.

STIHL M-Tronic™ remembers the settings from the last time the tool was used. So when external conditions are the same, optimal engine performance is available every time you start it.



MS 362 C-M

59.0 cc • 3.5 kW • 12.4 lb ②

The MS 362 C-M features our exclusive STIHL M-Tronic™ engine management technology. This innovative microprocessor-controlled engine management system optimizes engine performance and compensates for changes in operating conditions, such as temperature, elevation, fuel quality and dirty air filters.

Wrap-handle version available.



MS 362 C-M VW

59.0 cc • 3.5 kW • 12.7 lb ②

No matter what time of year, this saw will get the job done. It has all the features of the MS 362 C-M, with the added benefit of heated handles and carburetor.



MS 400 C-M

66.8 cc • 4.0 kW • 12.8 lb ②

The MS 400 C-M is the world's first chainsaw with a magnesium piston which enhances an already excellent power-to-weight ratio. This unit has excellent cutting performance for professional use in forests which is ideal for felling, delimiting, and preparation of wood in medium-density stands.





MS 462 C-M

72.2 cc • 4.4 kW • 13.2 lb Ⓜ

The lightest high-performance saw in the 70 cc class. Extraordinarily easy to manoeuvre, with outstanding acceleration. For felling and pruning in medium-density and high-density stands. Fitted with STIHL M-Tronic™ as standard; HD2 filter with very good filtering efficiency. Captive nuts on the sprocket cover make it easy to change the chain; tool-free fuel caps for easy and safe filling with fuels and lubricants; economical 2-MIX engine.

Wrap-handle version available.



MS 500i

79.2 cc • 5.0 kW • 13.7 lb Ⓜ

The **MS 500i** is the first chain saw in the world to feature electronically controlled fuel injection, making it a true innovation. When it comes to professionally harvesting large trees, this high-torque machine cuts through wood with ease.

Wrap-handle version available.



MS 462 C-M VW

72.2 cc • 4.4 kW • 13.4 lb Ⓜ

Weight-optimized high-power saw with heated handles and carburetor. The STIHL M-Tronic™ guarantees optimum engine performance at all times, while its single starting position and stop button function mean easy starting. Controlled delivery high-performance oil pump for high pumping capacity, HD2 filter with radial seal and tool-free fuel caps for simple, safe refuelling.

Wrap-handle version available.

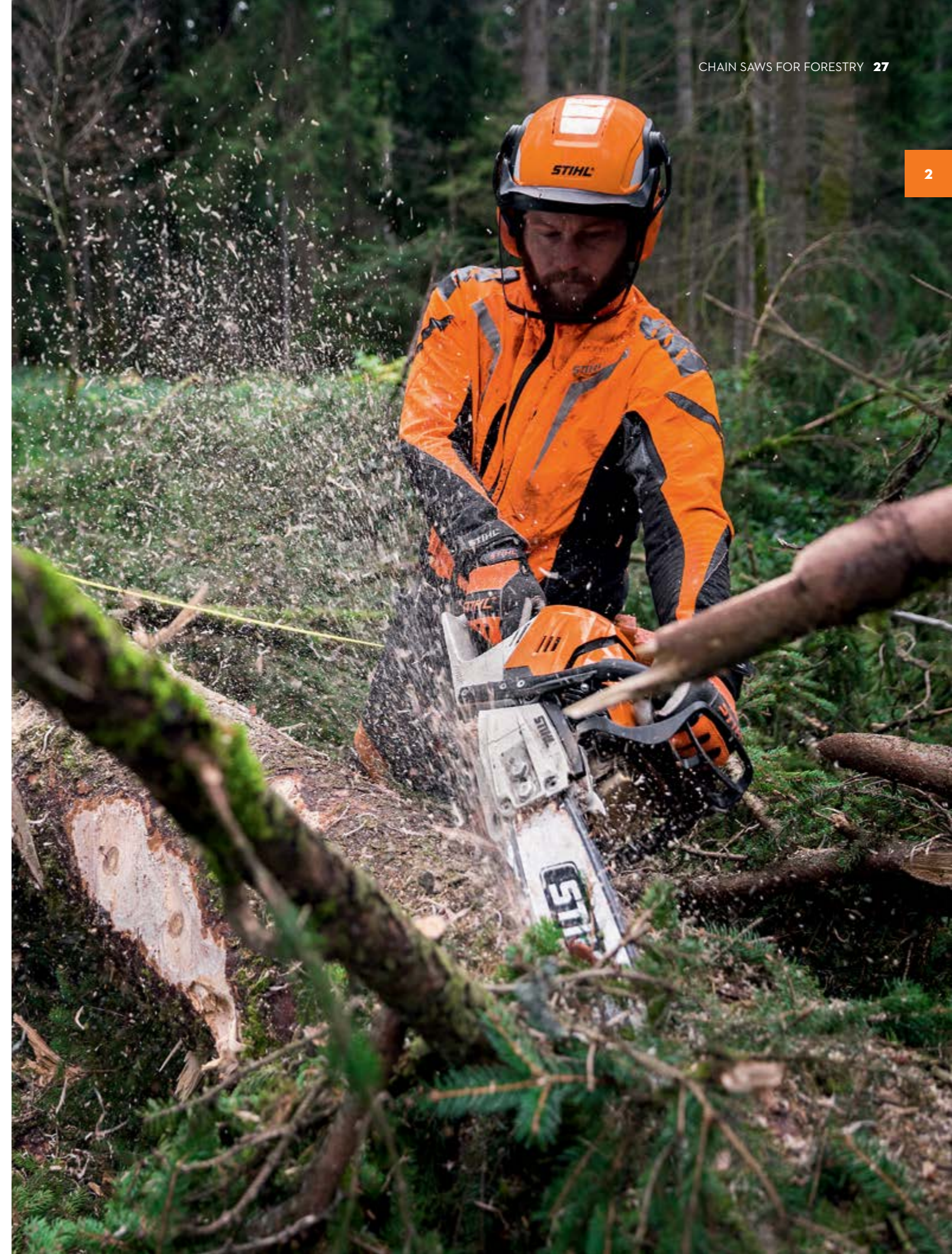



MS 661 C-M MAGNUM®

91.1 cc • 5.4 kW • 16.5 lb ②

The MS 661 C-M MAGNUM® chain saw has a high power to weight ratio and is the lightest chain saw in its engine displacement class. Because it's not just power that counts when you're harvesting large timber, but also every gram of weight. The extra powerful and efficient stratified scavenging engine allows you to work effectively, thanks to its high-cutting performance, low-emissions and improved anti-vibration system.

Wrap-handle version available.



MS 661 C-M MAGNUM® R

91.1 cc • 5.4 kW • 16.8 lb ②

The MS 661 C-M MAGNUM® R chain saw is equipped with the same cutting-edge technologies as the MS 661 C-M MAGNUM® with a standard wrap-handle. It features the M-Tronic™ fully electronic engine management system, which uses a microchip to control the engine's ignition timing and fuel supply, taking into account variables such as temperature, fuel quality and elevation. Take it to the max, with minimum effort.



MS 661 C-M MAGNUM® VW R

91.1 cc • 5.4 kW • 17.2 lb ②

This chain saw has the same robust features as the MS 661 C-M MAGNUM® with a standard wrap handle. This STIHL Arctic™ version heats the front and rear handles and carburetor for work in cold weather.



MS 881

121.6 cc • 6.4 kW • 21.6 lb ②

The most powerful chain saw on the market. The MS 881 is made for the toughest and most demanding jobs. Featuring STIHL's 2-MIX engine for high cutting performance, state-of-the-art oil pump for optimal oil flow and the HD2 filter system for longer service life.

IMPORTANT INFORMATION

WARNING: Improper use of any power tool may cause serious or fatal injury. Read, understand and follow carefully the operating and safety instructions in your operator's manual before using these products.

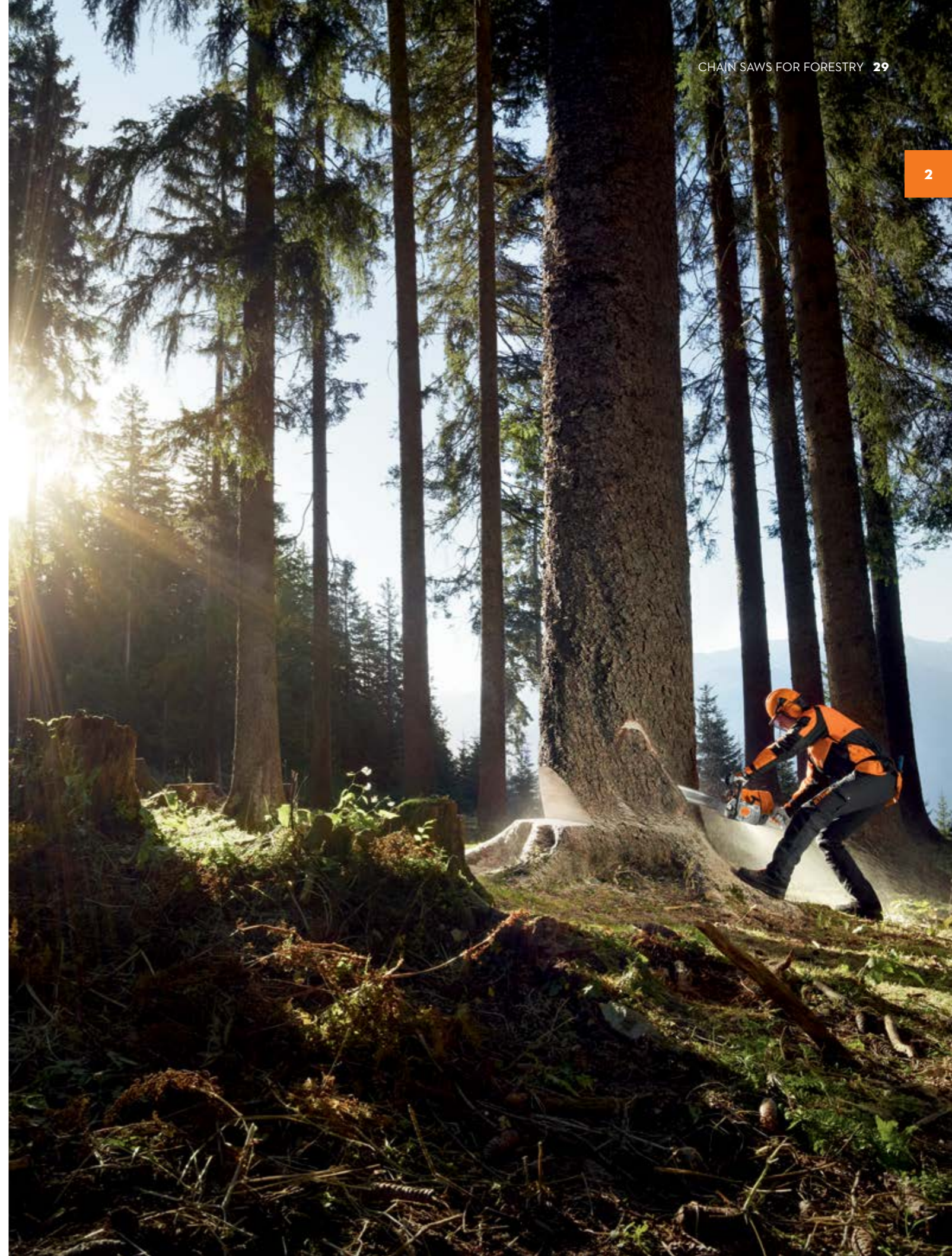



MS 462 RS RESCUE SAW

76.5 cc • 4.4 kW • 7.8" • 15.4 lb ©

MATERIALS THAT CAN BE CUT INCLUDE THE FOLLOWING:

- ARMoured GLASS - TRAIN WINDOWS
- SHEET STEEL
- COPPER OR ALUMINUM SHEET
- ROOFING FELT
- WOODEN STRUCTURES WITH NAILS
- LIGHT MASONRY (DRYWALL, HARDBOARD)
- ALUMINUM ROLL-UP DOORS
- SHINGLES

APPLICATIONS INCLUDE:

- Cutting ventilation openings in roofs and wooden structures during firefighting to allow smoke, toxic gases and heat to escape; this is an important supplement to forced ventilation.
- Searching for the seat of a fire, particularly in the case of smoldering fires in the roofs of industrial buildings.
- Cutting access gaps in multiple wall structures.

© DRY, WITHOUT GUIDE BAR AND CHAIN.



01 Large starter handle makes it easier to grip and start the saw when wearing heavy protective gloves. Optional: shipped with a large D-shaped handle (not installed).



02 The muffler shield separates the hot muffler from meltable materials. This helps keep the muffler clean and operational.



03 Built-in holder keeps bar wrench handy. No fumbling or trying to find the bar wrench when the chain needs adjustment.

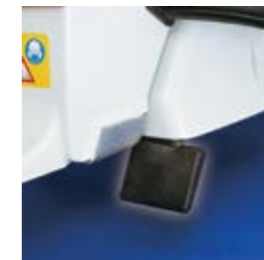

04 Extended chip deflector helps guide chips away from the operator.



05 The STIHL RAPID™ Duro Rescue (RDR) chain has carbide cutters designed to cut through a variety of materials. For more information, see page 63.

ARBORIST CHAIN SAWS

Professional tree service, maintenance of public roads and parks; these are the preferred applications for STIHL's special purpose saws. These machines are exceedingly compact and can therefore be guided with absolute accuracy.



MS 151 T C-E

23.6 cc • 1.1 kW • 5.7 lb ②

Light in weight, but definitely not lightweight in its performance. The MS 151 T C-E features STIHL's Easy2Start™ system for effortless starting and with an optimum power-to-weight ratio, low-vibrations, reduced fuel consumption and reduced emissions. This saw is the perfect tool for tree pruning and other professional use.

T Handle Version - recommended for professional use only.

Easy 2 Start™



MS 194 T

31.8 cc • 1.4 kW • 7.3 lb ②

The MS 194 T professional gas top handle chain saw is great for tree care companies, road maintenance and municipalities, and garden and landscape professionals. The unit features more power, more torque and better fuel consumption than the previous model.

T Handle Version - recommended for professional use only.



MS 194 C-E

31.8 cc • 1.4 kW • 7.7 lb ②

This rear handle chain saw is the perfect partner for tough tree maintenance jobs along roads or in parks and orchards. It combines performance with low weight and uncompromising user comfort plus the Easy2Start™ system for effortless starting. Its fuel-efficient 1.3 kW stratified scavenging engine, compact design and sophisticated features such as the captured nut on the sprocket cover and fold-down carrying loop guarantee that this tool will never let you down.

Easy 2 Start™



STIHL EASY2START™

The Easy2Start™ system uses dual spring technology. The operator can slowly pull the starter cord, which winds the second spring. When this spring overcomes the piston's compression, it suddenly releases, starting the engine. This advanced starting system is designed to make starting STIHL products fast and easy for just about anyone.

Easy 2 Start™



MS 201 C-M

35.2 cc • 1.8 kW • 9.1 lb ②

The MS 201 C-M is a compact, super-light powerhouse. Like the MS 201 T C-M, it features the PS3 full chisel saw chain and the filter service life in both models is twice that of the previous models.



MS 201 T C-M

35.2 cc • 1.8 kW • 8.2 lb ②

The MS 201 T C-M is the lightweight powerhouse for professional arborists, road maintenance crews and landscaping companies. Featuring a STIHL PICCO™ exclusive: low-vibration, low-kickback 3/8" P Super 3 (PS3) full chisel saw chain.

T Handle Version - recommended for professional use only.

POLE PRUNERS

STIHL pole pruners are perfect for professional tree maintenance. Thanks to high torque, even thick branches can be cut effortlessly.



HT 56 C-E

27.2 cc • 0.8 kW • 9.2 ft • 14.7 lb ①

The HT 56 C-E is a low-emission and fuel-efficient pole pruner for homeowners. Complete with STIHL's Easy2Start™ technology, the pruner is lightweight and features a unique, two-piece shaft design for easy storage and transport.

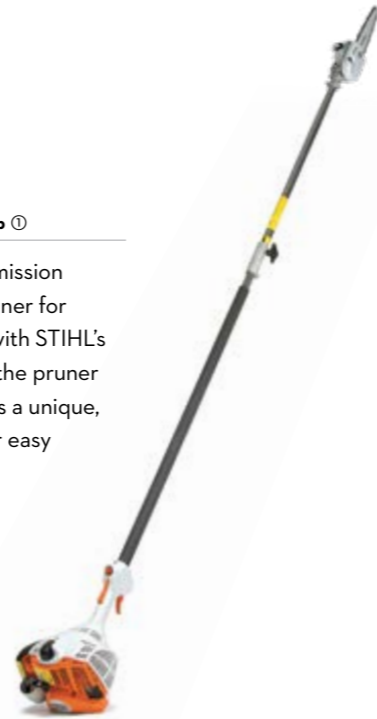

HT 105

31.4 cc • 1.05 kW • 8.9-12.8 ft • 17.4 lb ①

The HT 105 is a professional grade pole pruner for orchard and arborist work. Lightweight and compact transmission with captive nut on the sprocket cover. Increase your cutting performance with the 1/4" PM3 saw chain and 4-MIX™ engine with a simplified start system. Highly ergonomic and very stable due to the reduced weight of the square-cut telescopic shaft.



HT 135

36.3 cc • 1.4 kW • 9.4-13.3 ft • 17.4 lb ①

The most powerful gas pole pruner in the STIHL line-up with STIHL 4-MIX® engine for professional work in tree maintenance, orchards and local municipalities. For delimiting trees, removing dead wood or breakage from storms, and for cutting back trees. 3/8" PM3 saw chain, lightweight and compact transmission with cast-on robust branch hook. Features a professional telescopic shaft with rapid adjustment for precise biting characteristics and a precise cut. Total length 270 - 390 cm.

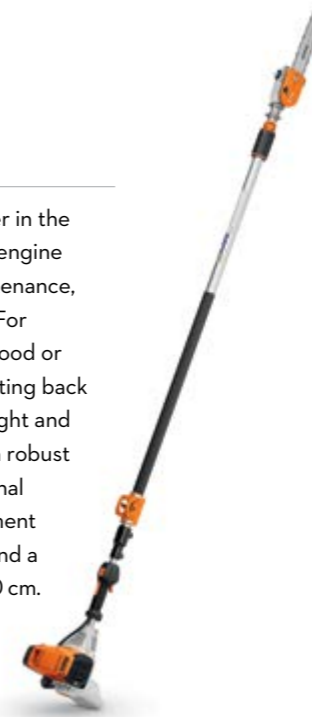

CARRIER HARNESS

For pole pruners and long reach hedge trimmers.

0000 790 4400



NEW HT FLEX BELT

Clips to the ADVANCE X-TREEm HT forestry harness.

0000 710 9003



NEW ADVANCE X-TREEm HT FORESTRY HARNESS

The ADVANCE X-TREEm HT Forestry Harness, used in combination with the HT Flex Belt provides the perfect ergonomic design for forestry maintenance. Can be combined with accessories from the ADVANCE X-FLEX Harness System.

0000 710 9002

① WEIGHT WITHOUT FUEL.

IMPORTANT INFORMATION

WARNING: Improper use of any power tool may cause serious or fatal injury. Read, understand and follow carefully the operating and safety instructions in your operator's manual before using these products.

	Displacement (CC)	Power output (KW)	Weight (LB) @	Available bar length	OILOMATIC® saw chain pitch/type	Chain tensioning at the side	Quick Chain Adjuster (B)	STIHL Quikstop® Super chain brake	Primer pump	Decompression valve	ElastoStart™	Easy2Start™ (E)	STIHL M-Tronic™ (M)	Compensator	Tool-less filler caps	Electronically heated handle and carburetor (VW)
CHAIN SAWS FOR PROPERTY MAINTENANCE																
MS 162	31.8	1.4	10.4	16	3/8"/PMM3	-	-	-	-	-	○	-	-	-	-	-
MS 172 C-E	31.8	1.4	10.4	14-16	3/8"/PMM3	-	○	-	-	-	○	-	-	-	-	-
MS 182	35.8	1.6	10.1	16	3/8"/PM3	-	●	-	-	-	○	-	-	-	-	-
MS 212	38.6	1.8	10.1	14-16	3/8"/PMM3	-	●	-	-	-	○	-	-	-	-	-
MS 250	45.4	2.3	10.1	16-18	.325"/RSP	●	-	-	-	-	○	-	●	●	-	-
MS 250 C-BE	45.4	2.3	10.8	16-18	.325"/RSP	-	●	-	●	-	-	●	●	●	-	-
MS 251	45.6	2.2	10.8	16-18	.325"/RSP	●	-	-	-	-	-	-	●	●	-	-
MS 251 C-BE	45.6	2.2	11.5	16-18	.325"/RSP	-	●	-	●	-	-	●	●	●	-	-
CHAIN SAWS FOR FARMING & LANDSCAPING																
MS 271	50.2	2.6	12.3	16-20	.325"/RSP	●	-	-	-	-	○	-	-	●	●	-
MS 291	55.5	2.8	12.3	16-20	.325"/RSP	●	-	-	-	-	○	-	-	●	●	-
MS 291 C-BE	55.5	2.8	13.7	16-20	.325"/RSP	-	●	-	-	-	-	●	-	●	●	-
MS 391	64.1	3.3	14.1	16-24	3/8"/RSP	●	-	-	-	●	○	-	-	●	●	-
CHAIN SAWS FOR FORESTRY																
MS 261 C-M	50.2	3.0	10.8	16-20	.325"/RS	●	-	-	-	●	●	-	●	●	●	-
MS 261 C-M VW	50.2	3.0	12.0	16-20	.325"/RS	●	-	-	-	●	●	-	●	●	●	●
MS 362 C-M	59.0	3.5	12.4	16-24	3/8"/RS	●	-	-	-	●	●	-	●	●	●	-
MS 362 C-M VW	59.0	3.5	12.7	16-24	3/8"/RS	●	-	-	-	●	●	-	●	●	●	●
MS 400 C-M	66.8	4.0	12.8	16-28	3/8"/RS	●	-	-	-	●	●	-	●	●	●	●
MS 462 C-M MAGNUM®	72.2	4.4	13.2	16-32	3/8"/RS	●	-	-	-	●	●	-	●	●	●	-
MS 462 C-M MAGNUM® VW	72.2	4.4	13.4	20-36	3/8"/RS	●	-	-	-	●	●	-	●	●	●	●
MS 500I	79.2	5.0	13.7	20-36	3/8"/RS	●	-	-	-	●	●	-	-	-	●	-
MS 661 C-M MAGNUM®	91.1	5.4	16.5	20-36	3/8"/RS	●	-	-	-	●	●	-	●	●	●	-
MS 661 C-M MAGNUM® R	91.1	5.4	16.8	20-36	3/8"/RS	●	-	-	-	●	●	-	●	●	●	-
MS 661 C-M MAGNUM® VW R	91.1	5.4	17.2	20-36	3/8"/RS	●	-	-	-	●	●	-	●	●	●	●
MS 881	121.6	6.4	21.6	24-60	.404"/RS	●	-	-	-	●	●	-	-	●	●	-
MS 462 RS RESCUE SAW	76.5	4.4	15.8	20	3/8"/RDR	●	-	-	-	●	●	-	-	●	●	-

- Standard
 - Can be retrofitted (special accessory)
 - ① Weight without fuel.
 - ② Dry, without guide bar and chain.
 - † Without battery, guide bar and chain.
- Conversion Formula kW x 1.341 = bhp (ch)

CHAIN SAW FEATURE

DESIGNATIONS:

- B** Quick Chain Adjuster (QCA)
- E** Easy2Start™
- i** Fuel Injection
- M** STIHL M-Tronic™
- Q** STIHL Quikstop® super chain brake
- C** Comfort

OTHER FEATURES:

- VW** Heated handle and carburetor
- R** Wrap handle
- T** Top handle (on the nameplate)

Example: MS 291 C-BE
 This saw has a Quick Chain Adjuster (B) and the Easy2Start™ system (E).

Note: Models and specifications are subject to change without notice. Manufacturer reserves the right to change appearance, function and components of any STIHL product without prior notice or liability.

Note: Specifications are as of January 1, 2024. For most recent updates, visit www.stihl.ca. Models and specifications are subject to change without notice. Manufacturer reserves the right to change appearance, function and components of any STIHL product without prior notice or liability.

IMPORTANT INFORMATION

WARNING: The occurrence called “kickback” can cause serious or fatal injury. Always read the operator’s manual carefully before using your chain saw. Ask your STIHL Dealer about safe operating procedures. Improper use of any power tool may cause serious or fatal injury. Read, understand and follow carefully the operating and safety instructions in your operator’s manual before using these products.

	Displacement (CC)	Power output (KW)	Weight (LB) ②*	Available bar length	OILOMATIC® saw chain pitch/type	Chain tensioning at the side	Quick Chain Adjuster (B)	STIHL Quikstop® Super chain brake	Primer pump	Decompression valve	ElastoStart™	Easy2Start™ (E)	STIHL M-Tronic™ (M)	Compensator	Tool-less filler caps	Electronically heated handle and carburetor (VW)
ARBORIST CHAIN SAWS																
MS 151 T C-E	23.6	1.1	5.7 ②	10-12	1/4"/PM3	●	-	-	-	-	-	●	-	●	●	-
MS 194 T	31.8	1.4	7.3 ②	12-16	3/8"/PMM3	●	-	-	●	-	○	-	-	●	●	-
MS 194 C-E	31.8	1.4	7.9 ②	12-16	3/8"/PMM3	●	-	-	●	-	○	●	-	●	●	-
MS 201 T C-M	35.2	1.8	8.6 ②	12-16	3/8"/PS3	●	-	-	-	-	-	-	●	●	●	-
MS 201 C-M	35.2	1.8	8.6 ②	12-16	3/8"/PS3	●	-	-	-	-	-	-	●	●	●	-
POLE PRUNERS																
HT 56 C-E	27.2	0.8	14.7 ②	10	1/4"/PM3	●	-	-	●	-	○	●	-	-	●	-
HT 105	31.4	1.05	15.9 ②	12	1/4"/PM3	●	-	-	●	●	○	-	-	-	●	-
HT 135	36.3	1.4	17.4 ②	12	3/8"/PMM3	●	-	-	●	●	○	-	-	-	●	-

- Standard
 - Can be retrofitted (special accessory)
 - ① Weight without fuel.
 - ② Dry, without guide bar and chain.
 - † Without battery, guide bar and chain.
- Conversion Formula kW x 1.341 = bhp (ch)

CHAIN SAW FEATURE

DESIGNATIONS:

- B** Quick Chain Adjuster (QCA)
- E** Easy2Start™
- i** Fuel Injection
- M** STIHL M-Tronic™
- Q** STIHL Quikstop® super chain brake
- C** Comfort

OTHER FEATURES:

- VW** Heated handle and carburetor
- R** Wrap handle
- T** Top handle (on the nameplate)

Example: MS 291 C-BE
This saw has a Quick Chain Adjuster (B) and the Easy2Start™ system (E).

Note: Models and specifications are subject to change without notice. Manufacturer reserves the right to change appearance, function and components of any STIHL product without prior notice or liability.

Note: Specifications are as of January 1, 2024. For most recent updates, visit www.stihl.ca. Models and specifications are subject to change without notice. Manufacturer reserves the right to change appearance, function and components of any STIHL product without prior notice or liability.

IMPORTANT INFORMATION

WARNING: The occurrence called “kickback” can cause serious or fatal injury. Always read the operator’s manual carefully before using your chain saw. Ask your STIHL Dealer about safe operating procedures. Improper use of any power tool may cause serious or fatal injury. Read, understand and follow carefully the operating and safety instructions in your operator’s manual before using these products.

Note: Specifications are as of January 1, 2024. For most recent updates, visit www.stihl.ca. Models and specifications are subject to change without notice. Manufacturer reserves the right to change appearance, function and components of any STIHL product without prior notice or liability.

GET ATTACHED.

43 **HEXA SAW CHAIN
& HEXA FILE**

48 **CHAIN TECHNOLOGY FOR
EVERY APPLICATION**

44 **LONG-LIFE
SAW CHAINS**

49 **IDENTIFYING STIHL
SAW CHAINS**

46 **GUIDE BARS**





STIHL SAW CHAINS AND GUIDE BARS

FOR MAXIMUM PRECISION AND PRECISE CUTS

Felling, delimiting, thinning out, processing: whatever you plan to use your chainsaw or pole pruner for, you'll be well equipped for any task with the wide range of STIHL saw chains and guide bars.

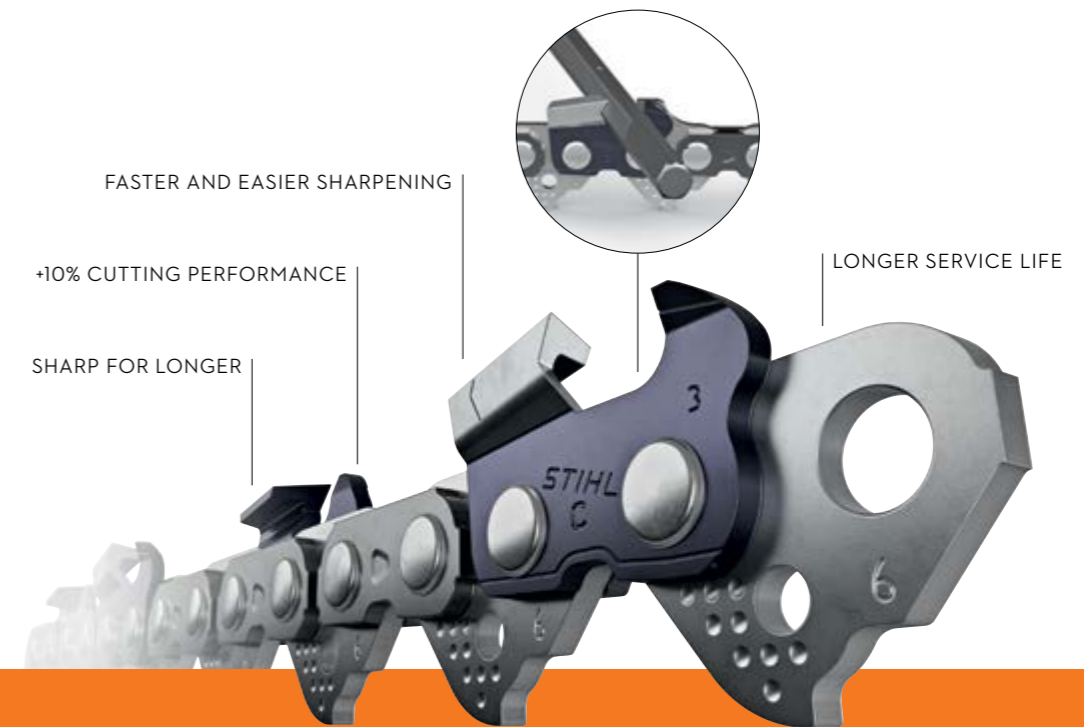

HEXA SAW CHAIN + HEXA FILE

THE STIHL EXCLUSIVE PROFESSIONAL CUTTING SYSTEM

With the patented Hexa cutting system consisting of the Hexa saw chain and Hexa file, STIHL is setting new standards in terms of performance, sharpening, and service life. Are efficiency and time savings particularly important to you in your day-to-day work? Then Hexa is the right solution for you! Hexa saw chains not only feature impressive cutting performance but also straightforward handling. The shapes of the cutting teeth and file are ideally coordinated to each other, and enable particularly straightforward and rapid sharpening with an almost perfect result. Compared with other saw chains such as the $\frac{3}{8}$ " RS, the Hexa also needs re-sharpening much less frequently, resulting in a longer service life. Try the new STIHL Hexa cutting system today and see for yourself!



Video instructions on how to sharpen the Hexa saw chain are available at: stihl.com/hexa

✓ +10% CUTTING PERFORMANCE

In conjunction with the narrow kerf, the special Hexa finish of the $\frac{3}{8}$ " Rapid Hexa saw chain gives a 10% improvement in cutting performance compared with the $\frac{3}{8}$ " Rapid Super saw chain - for maximum output during felling work.

✓ SHARP FOR LONGER

As the shapes of the file and cutting tooth are perfectly coordinated one another, the Hexa saw chain can be perfectly sharpened, saws more quickly, and stays sharp for significantly longer.

✓ QUICKER AND EASIER SHARPENING

The optimum fit of the Hexa cutting tooth and Hexa file also makes sharpening much quicker and easier than with a round file. The ideal sharpening angles are achieved every time the tool is sharpened.

✓ LONGER SERVICE LIFE

As the $\frac{3}{8}$ " RH saw chain needs sharpening less often, its service life is also correspondingly longer.

LONG-LIFE SAW CHAINS

The right choice of chain is essential for economical chain saw use. STIHL supplies a wide range of chains ideal for every application, for every performance class and for every make of chain saw. All chains are characterized by their robust, unsurpassed quality.



STIHL RAPID HEXA CHAIN

A revolutionary cutting system designed for professionals. This 3/8" chain features a V-shaped cutting edge and a narrow kerf top plate, resulting in a 10% increase in cutting performance compared to the 3/8" RS. The 6-angled file patented by STIHL provides a perfect sharpening angle which allows for faster and easier sharpening, significantly increasing the lifetime of the chain.



STIHL PICCO™ DURO (PD3) CHAIN

The first ever carbide-tipped low-profile saw chain. The chain remains sharp, without refiling, for up to four times longer than standard chain and is also a low-vibration, reduced-kickback chain.



CARBIDE-TIPPED SAW CHAIN

Resistance is futile: the Duro 3 carbide-tipped saw chain stays sharp for at least four times longer than conventional saw chains, even in extreme conditions. The extra hard cutters resist dulling, even if they come into contact with the ground and they're specially designed to handle wood contaminated with cement residues. So you can cut yourself some slack when it comes to sharpening your chain.



STIHL RAPID™ DURO 3 (RD3) CHAIN

Reduced-kickback and vibration levels; stays sharp for up to four times longer than standard saw chain. Offers excellent cutting performance, even under demanding conditions. Pro model in .325", .050" with narrower kerf also available (RDP3).



STIHL RAPID™ SUPER 3 (RS3) CHAIN

High-performance saw chain for professional applications offering reduced kickback, low-vibration levels, smooth cutting, low-chatter and extremely high cutting and boring performance.



STIHL PICCO™ MICRO™ 3 (PM3) CHAIN

Available in 1/4" and 3/8", the STIHL PICCO™ Micro™ low-profile chains are for use on light chain saws and pole pruners. Features an exceedingly low-kickback, ideal for a wide variety of jobs.



STIHL RAPID™ MICRO™ (RM) CHAIN

Ideal all-round 3/8" and .325" chain for use on farms, in the forest and in the construction industry, with particularly good guiding properties and high-cutting performance. This chain produces very low vibrations. Pro model in .325", .050" with narrower kerf also available (RMP).



STIHL RAPID™ MICRO™ (RMX) RIPPING CHAIN

This 3/8", .050" gauge chain is specially designed for milling applications. Produces very low vibrations.



STIHL RAPID™ SUPER (RS) CHAIN

For professional use, producing outstanding results. This chain features a raised back of the cutter and tie straps to reduce vibrations by up to 70%. This heavy-duty chain is ideal for use on machines rated at more than 2.5 kW. Pro model in .325", .050" with narrower kerf also available (RSP).



STIHL PICCO™ MICRO™ MINI 3 (PMM3) CHAIN

A low-profile chain for use on light chain saws and pole pruners, offering reduced kickback. Hard-wearing saw chain with especially high cutting performance, thanks to a very narrow kerf.



36 GBM CHAIN

This 3/8", .063" gauge chain has been specially designed for the GS 461 concrete cutter and features diamond segments for cutting concrete and natural stone.



36 GGM CHAIN

Designed for the cutting of ductile cast iron pipes, the diamond abrasive chain is used with the GS 461 Rock Boss™. The robust 3/8", .063" gauge chain offers a long service life and a high degree of performance. This chain requires a specific bar designed for ductile iron.



STIHL PICCO™ SUPER (PS) CHAIN

Apart from the 3/8" PS3 chain, this is the only PICCO™ full chisel tooth chain on the market. Significantly better cutting performance with 15% less vibration. Excellent biting performance; produces a very clean cutting surface. Ideal for professional forestry applications.



STIHL PICCO™ SUPER 3 PRO (PS3) CHAIN

The first ever 3/8" low-profile chisel tooth saw chain in the world. Considerably greater cutting performance, with quiet operation, excellent biting characteristics and low-vibration.



STIHL RAPID™ DURO R (RDR) CHAIN

This 3/8" chain has been specifically designed for the STIHL emergency services saw and features teeth reinforced with tungsten carbide and cobalt for strength.



RMHS - HARVESTER CHAIN

For use on harvester heads, produces outstanding results. This heavy-duty chain has 70% longer life than comparable harvester chains.



36 GBE CHAIN

This entry-level diamond abrasive chain for the GS 461 is an affordable alternative to the 36 GBM chain with diamond segments on every other drive link.

GUIDE BARS

The demands imposed on guide bars are considerable. The bar must guide the chain accurately with minimal friction loss. Together with the sprocket and chain, it must convert the engine power into cutting performance with as little loss as possible. Moreover, the guide bar must withstand the toughest conditions without warping.

STIHL ROLLOMATIC® ES LIGHT



STIHL ROLLOMATIC® E

The body of the STIHL ROLLOMATIC® E (Ematic™) is made of three electrically welded metal plates. The middle plate is largely hollowed out. The benefit of this is excellent stability combined with a very low-weight. To cover a wide range of applications, the STIHL ROLLOMATIC® E guide bars are produced with two different sized bar noses (sprocket noses).



STIHL ROLLOMATIC® ES LIGHT

A lightweight version of the STIHL ROLLOMATIC® ES (Ematic™ Super), made from hard-wearing special steel. Material from the centre of the bar is cut out and removed, then precision welded. This process produces an extremely stable hollow body with a flexible upper end substructure. The result is a weight reduction of 30% in comparison to ROLLOMATIC® ES guide bars.



STIHL ROLLOMATIC® ES

The STIHL ROLLOMATIC® ES (Ematic™ Super) is composed of a solid and particularly rigid bar with a bar nose which can be replaced entirely. Elliptically formed angled oil holes increase the flow rate of the chain oil, delivering optimal lubrication and an even longer service life for the guide bar.



STIHL ROLLOMATIC® E MINI

The STIHL ROLLOMATIC® E Mini guide bar is great for pruning, cutting firewood, and storm cleanup. For use with chain saws and pole pruners using the 1/4" STIHL PICCO™ saw chain



STIHL ROLLOMATIC® G

The STIHL ROLLOMATIC® G is designed specifically for the GS 461. The extremely durable solid bar is made of special reinforced steel and developed to work under the toughest conditions.



STIHL DUROMATIC® E

The STIHL DUROMATIC® E (Ematic™) is an exceptionally robust solid bar for chain saws in the middle and high-performance categories. The bar itself is made of extremely strong solid steel. The bar nose, which is exposed to the greatest stress, is protected by a carbide alloy plating.



STIHL CARVING

A high quality guide bar for carving work. It extremely low kickback, make it suitable for carving details and tight angles. Laser markings on the bar nose facilitate precise guidance when cutting.



STIHL LIGHT 01

Three-piece welded guide bar for use with chain saws and pole pruners using 1/4" and 3/8" pitch saw chains, a single rivet in the nose.



STIHL LIGHT 04

The standard version of this STIHL guide bar consists of three electrically welded metal plates and four-rivet sprocket nose.



STIHL LIGHT 06

Robust electrically welded guide bar for the toughest applications, recognizable by the six rivets on the sprocket nose. Use with 3/8" pitch saw chains.



IDENTIFYING STIHL SAW CHAINS

STIHL uses a Marketing Number System in addition to the part number. This allows easy identification of any chain. For example, a chain with a Marketing Number of 33RS3:

Pitch	Gauge	Type	Shape	Special
3	3	R	S	3
3/8"	.050"	STIHL	Super RAPID™	Single-Humped Tie Strap

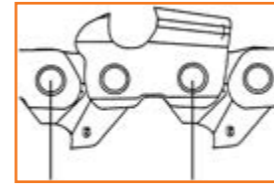

PITCH

- 1 = 1/4"
- 2 = .325"
- 3 = 3/8"
- 4 = .404"
- 6 = STIHL PICCO™ (3/8" Extended)
- 7 = STIHL PICCO™ Micro™ (1/4" / .043")

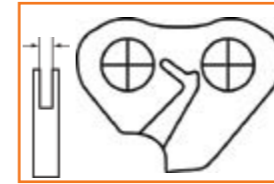

GAUGE (ON DRIVE LINK)

- 1 = .043"/1.1 mm
- 3 = .050"/1.3 mm
- 5 = .058"/1.5 mm
- 6 = .063"/1.6 mm
- 0 = .080"/2.0 mm (2.0 - Harvester Chain only)

CUTTER TYPE

- H = Hexa
- P = STIHL PICCO™
- R = STIHL RAPID™

CUTTER SHAPE

- D = Duro (Carbide Tip)
- DP = Duro Pro
- DS = Duro Special (Carbide Tip)
- H = Hexa
- M = Micro™
- MP = Micro™ Pro
- R = Rescue (RDR chain, specially designed for MS 462 R STIHL Rescue)
- S = Super (Chisel)
- SP = Super (Chisel) Pro

SPECIAL

- 3 = Single-Humped Drive Link
- F = Full Skip
- H = Semi Skip (Half-Skip) or Harvester (i.e. on .404" RMHS)
- K = Classic Cutter design
- L = Square Ground
- P = Professional
- S = Special
- X = Ripping

NUMBER OF DRIVE LINKS ON REELS

Type	100' Reel
1/4"	600**
3/8" STIHL PICCO™	1640
.325"	1840
3/8"	1640
.404"	1480
.080"	740***

** Sold in 25' reels only. *** Sold in 50' reels only.

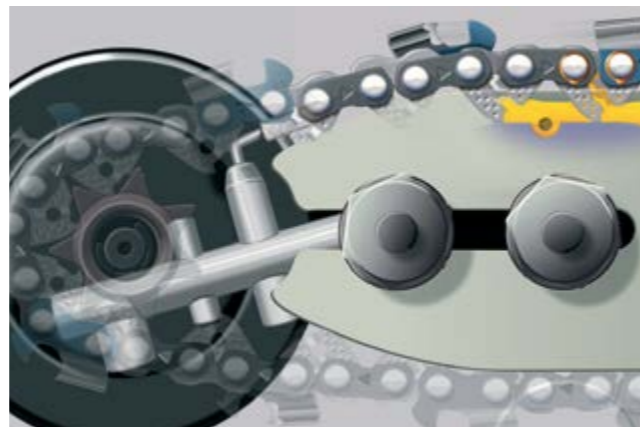

STIHL OILOMATIC® LUBRICATION SYSTEM

This system reduces friction and wear, which extends the service life of the cutting attachment. Elliptically formed angled oil holes increase the flow rate of the chain oil, delivering optimal lubrication for an even longer service life for the guide bar.

STIHL EMATIC™ SYSTEM

Compared to conventional bars without Ematic™, the Ematic™ system reduces the consumption of chain lubricant by up to 50% depending on the type of wood and the cutting attachment used. This system comprises an Ematic™ or Ematic™ S guide bar, a STIHL OILOMATIC® saw chain and a variable-flow or reduced-flow oil pump. Virtually every drop of chain lubricant is delivered to exactly the right spot.

Note: Specifications are as of January 1, 2024. For most recent updates, visit www.stihl.ca. Models and specifications are subject to change without notice. Manufacturer reserves the right to change appearance, function and components of any STIHL product without prior notice or liability.

STIHL CUTTING ATTACHMENT COMBINATIONS (FOR STIHL CHAIN SAWS BELOW 80 CC DISPLACEMENT AS COMPLYING WITH CSA STANDARD Z62.3-2004)	Pitch	Guide bar length*	Chain complying with CSA Standard Type A	Chain complying with CSA Standard Type C (Low Kickback Chain)
MS 162, 170, 171, 172, 180, 181	3/8"P	14", 16"	61 PMM3	61 PMM3, 63 PM3
MS 180, 182, 211, 212	3/8"P	14", 16"	61PS3 Pro	61PS3 Pro
MS 194	3/8"P	12", 14", 16"	61 PMM3	61 PMM3
MS 211	3/8"P	12", 14", 16"	63 PM3	63 PM3, 61 PMM3
MS 201	3/8"P	12", 14", 16"	63 PS3	63 PS3
MS 241	3/8"P	14", 16", 18"	63 PS	63 PS3
MS 231, 250, 251	.325"	16", 18"	23 RSP, 23 RMP	23 RMP3
MS 261, 271	.325"	16", 18", 20"	23 RSP, 23 RMP	23 RMP3
MS 291	.325"	16", 18", 20"	23 RSP, 23 RMP	23 RMP3
MS 391, 362, 400, 500	3/8"	16", 18", 20"	33 RS, 33 RM	33 RS3
MS 441, 461, 462	3/8"	16", 18", 20"	33 RS, 33 RM	33 RS3
MS 151	1/4"P	12"	71 PM3	71 PM3

Guide bar lengths and saw chain designations in **bold** type are standard cutting attachments. These replacement saw chains meet the kickback performance requirements for Types A and C reduced and low-kickback saw chains of CSA-Z62.3-2004 when tested on a representative sample of chain saws. *Guide bar length; depending on powerhead type, the effective cutting length can vary up to an inch.



KEEP WILDERNESS IN CHECK.

52 TRIMMERS

54 BRUSHCUTTERS

58 CLEARING SAWS

60 NYLON LINES

62 ACCESSORIES FOR
BRUSHCUTTERS &
CLEARING SAWS

64 MOWING HEADS &
CUTTING TOOLS

66 OVERVIEW OF
BRUSHCUTTERS &
CLEARING SAWS

TRIMMERS

STIHL trimmers quickly maintain grass and brush order, along the side of the house or walls, around or under bushes. When fitted with the appropriate cutting tool, they are also suitable for heavier jobs around your property.



FS 38

27.2 cc • 0.65 kW • 9.3 lb ③

Lightweight gas-powered trimmer for occasional use with adjustable handle and dual line AutoCut® C 6-2.



FS 40 C-E

27.2 cc • 0.7 kW • 9.9 lb ③

Lightweight and reliable, the FS 40 C-E trimmer provides balanced operation, increased power and effortless starting with STIHL's Easy2Start.

Easy 2 Start™



FS 50 C-E

27.2 cc • 0.8 kW • 10.1 lb ③

The FS 50 C-E offers comfort for taller users due to the longer shaft, and is equipped with all of the features of the FS 40 C-E with increased power output.

Easy 2 Start™



③ WEIGHT WITHOUT FUEL, CUTTING ATTACHMENT OR DEFLECTOR.

Note: STIHL recommends the use of fuel with no more than 10% Ethanol content. Using fuel with greater than 10% Ethanol content may cause damage to your equipment and may void your STIHL warranty.

IMPORTANT INFORMATION

WARNING: Improper use of any power tool may cause serious or fatal injury. Read, understand and follow carefully the operating and safety instructions in your operator's manual before using these products.



BRUSHCUTTERS

Tackling a landscaping job is much more appealing when the brushcutter is a trustworthy STIHL. Lightweight, powerful and easy-to-manoeuvre, STIHL brushcutters come equipped with an upright fuel tank for easy filling, a purge pump primer that allows you to prime the carburetor without flooding it and our trimmer line that is suitable for any job.



FS 56 RC-E

27.2 cc • 0.8 kW • 10.6 lb ⓘ

This machine features a fuel-efficient, low-emission engine, combined with a simplified starting procedure in a straight shaft version for extra reach. The Easy2Start™ technology makes this unit a breeze to start and comes equipped with a STIHL dual line AutoCut® 25-2 head.

Unit available in bike handle.

Easy 2 Start™



FS 70 R

27.2 cc • 0.9 kW • 10.6 lb ⓘ

This straight shaft brushcutter boasts a powerful, fuel-efficient engine, highly-durable cable drive shaft, forged connecting rod and heavy duty gearbox.



Note: Additional Bike Handled Version Available - see table on page #

Note: Barrier bar and large deflector must be attached when using a grass blade with loop handle (R) trimmer.

FS 91 R

28.4 cc • 0.95 kW • 12.1 lb ⓘ

A great choice for environmentally conscious users. Engineered specifically for the landscape pro in commercial applications.

Unit available in bike handle.

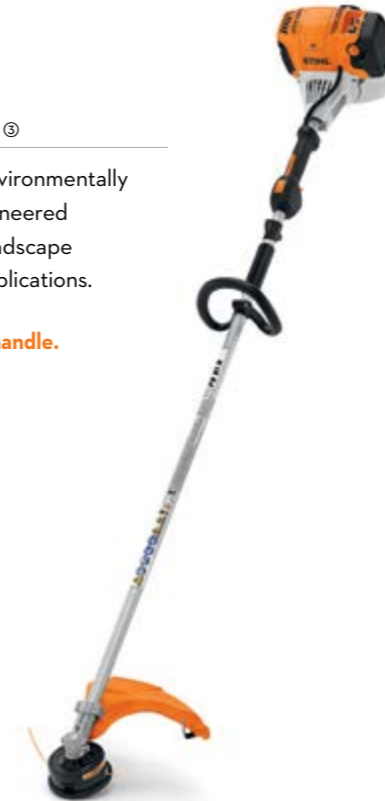

FS 94 R

24.1 cc • 0.9 kW • 10.1 lb ⓘ

Lightweight and compact brushcutter for demanding professional landscapers. Features an ECOSPEED adjuster allowing precise control of cutting speed and a fleece air filter for extended replacement intervals.

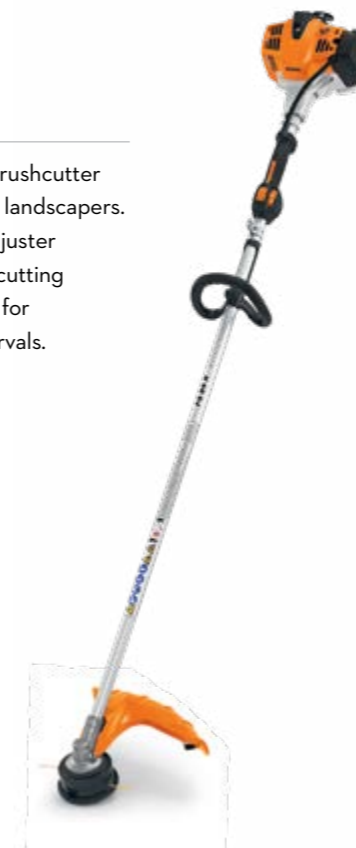

ⓘ WEIGHT WITHOUT FUEL, CUTTING ATTACHMENT OR DEFLECTOR.

FS 111 R

31.4 cc • 1.05 kW • 12.1 lb ⓘ

Fuel-efficient, powerful brushcutter that handles tough jobs and meets low-emission requirements. Now with a larger fuel tank for longer runtimes.

Unit available in bike handle.

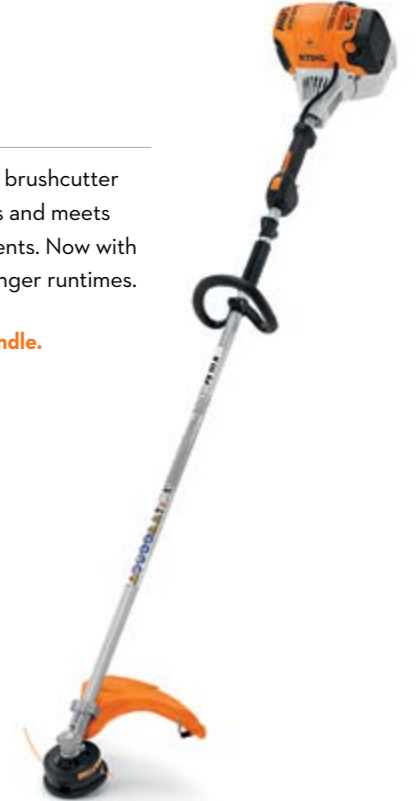

FS 111 RX

31.4 cc • 1.05 kW • 11.0 lb ⓘ

Designed for professional dedicated line head use. One of the best power-to-weight ratios in its class. This unit now comes with a larger fuel tank for longer runtimes.



FS 131 R

36.3 cc • 1.4 kW • 12.1 lb ⓘ

These heavy-duty brushcutters feature an incredible 33% increase in engine power over the FS 111 brushcutter, while maintaining an excellent power-to-weight ratio. Now with a larger fuel tank for longer runtimes.

Unit available in bike handle.

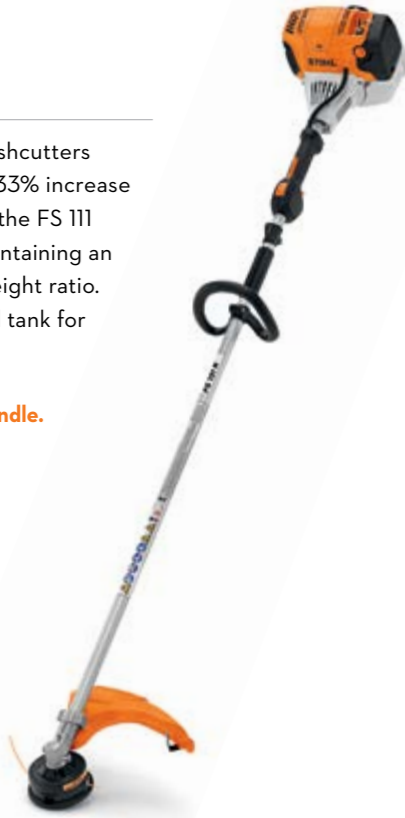

NEW

FS 251 R

41.6 cc • 2.0 kW • 14.6 lb ⓘ

The FS 251 R is built with a simplified starting procedure for professionals with no time to waste and is offers optimal maneuverability with its rugged design.

Unit available in bike handle.

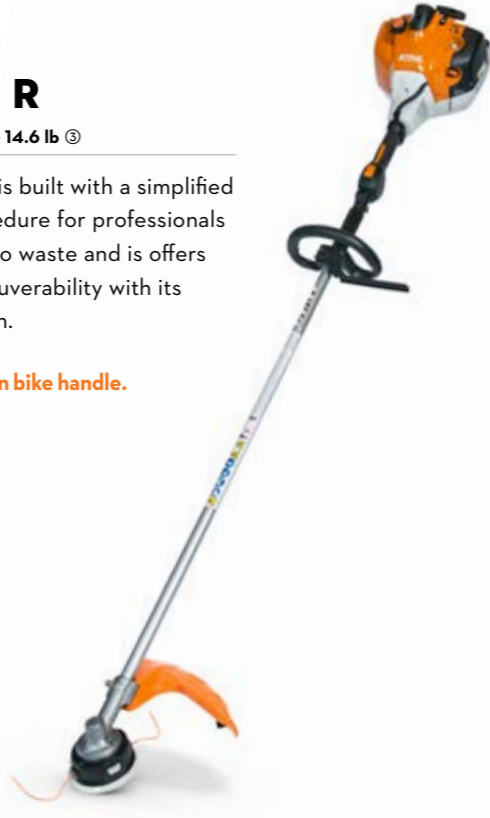

FS 240 R

37.7 cc • 1.7 kW • 14.6 lb ⓘ

This heavy-duty professional brushcutter combines rugged design with the versatility needed to attack extreme cutting situations. Ideal for cutting and clearing thick brush and overgrowth from ditches, roadways, pond banks and more.

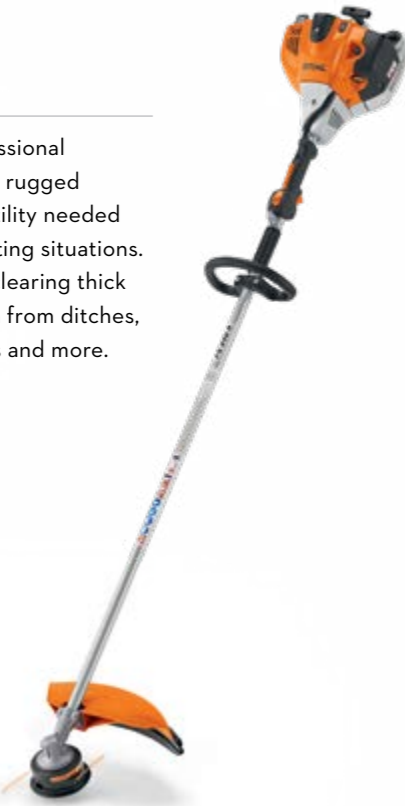

NEW

FS 261

41.6 cc • 2.0 kW • 16.9 lb ⓘ

Designed for tough and extensive mowing work. This powerful brushcutter features STIHL ErgoStart, 1-point anti-vibration system, and a impressive 520 mm cutting diameter.

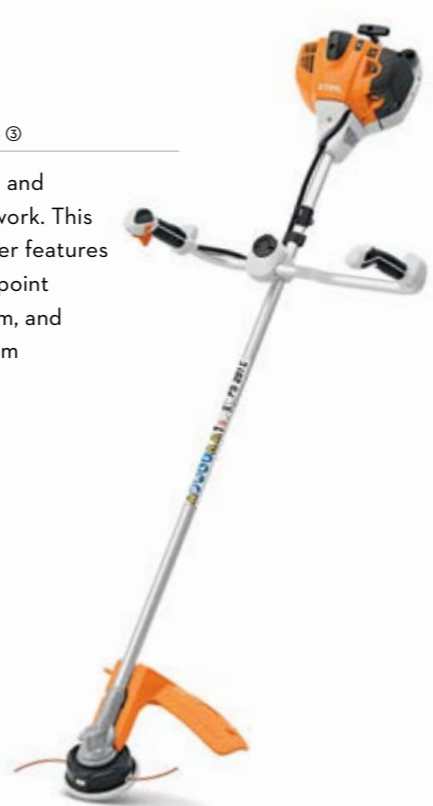

ⓘ WEIGHT WITHOUT FUEL, CUTTING ATTACHMENT OR DEFLECTOR.



BIKE OR LOOP HANDLE?

A loop handle is great when you need to manoeuvre the cutting head around obstacles. A bike handle is best when you will be using the brushcutter for long periods of time in mowing type operations. Let the harness carry the weight.



Note: Additional Bike Handled Version Available - see table on page #

Note: Barrier bar and large deflector must be attached when using a grass blade with loop handle (R) trimmer.

CLEARING SAWS

Features include comfortable ergonomics, durability, power and reliability. All models feature STIHL's Easy2Start™ technology, combined with exceptional runtimes thanks to increased fuel efficiency.



FS 361 C-EM

37.7 cc • 1.7 kW • 19.2 lb ③

Features an advanced STIHL M-Tronic™ electronic engine management system for maximum efficiency in changing conditions. Complete with Easy2Start™ and excellent fuel efficiency.



FS 460 C-EM K

45.6 cc • 2.2 kW • 18.5 lb ③

Comes standard with STIHL M-Tronic™ electronic engine management and Easy2Start™. Ideal for work in challenging areas of heavy grass and in forestry applications.



FS 561 C-EM

57.1 cc • 2.8 kW • 22.5 lb ③

Most powerful STIHL clearing saw in the range for professional forestry work. Extremely stable, powerful and durable.



③ WEIGHT WITHOUT FUEL, CUTTING ATTACHMENT OR DEFLECTOR.

Note: Barrier bar and large deflector must be attached when using a grass blade with loop handle (R) trimmer.



NYLON LINES

STIHL offers a comprehensive range of trimmer line for all STIHL line heads. Engineered from wear-resistant and long-lasting flexible material and available in different shapes, cross-sections and diameters. STIHL offers the best all-around characteristics such as abrasion and welding resistance, hygroscopic water-absorbing material, and flexibility over time and temperature ranges.

CF3 PRO CARBON LINE

The CF3 line is made from high quality polyamide and reinforced with carbon fibre which allows it to last three times longer compared to STIHL's premium line. Thanks to the twist, the whistling noise generated when mowing is noticeably quieter. The cruciform profile ensures improved mowing performance and neatly trimmed edges. The high-tech mowing line is compatible with most STIHL mowing heads.

'CF3' LINE	PART #
.080 - 1/2 LB	0000 930 4318
.080 - 1 LB	0000 930 4319
.095 - 1/2 LB	0000 930 4300
.095 - 1 LB	0000 930 4303
.095 - 3 LB	0000 930 4313
.095 - 5 LB	0000 930 4320
.105 - 1/2 LB	0000 930 4301
.105 - 1 LB	0000 930 4304
.105 - 3 LB	0000 930 4314
.105 - 5 LB	0000 930 4321
.130 - 1 LB	0000 930 4311
.130 - 3 LB	0000 930 4316
.130 - 5 LB	0000 930 4323



QUIET LINE

A helical groove embossed in the normal nylon line makes it quieter than conventional round nylon lines. The indentations in the surface of the line interrupt the otherwise uniform air stream, causing eddies and reducing the whistling effect, thus making this line quieter.

'X' LINE:

X .095 ø X .105 ø

REPLACEMENT NYLON LINE (REELS)

'X' TRIMMER LINE	PART #
.095 - 1 LB	0000 930 3410
.105 - 1 LB	0000 930 3411
.095 - 3 LB	0000 930 3401
.105 - 3 LB	0000 930 3404
.095 - 5 LB	0000 930 3402
.105 - 5 LB	0000 930 3405

PREMIUM LINE:

● .065 ø ● .080 ø ● .095 ø ● .105 ø ● .130 ø

REPLACEMENT NYLON LINE (REELS)

PREMIUM LINE, ROUND	PART #
.065 - 65'	0000 930 2334
.080 - 50'	0000 930 2335
.080 - 1/2 LB	0000 930 2336
.080 - 1 LB	0000 930 2337
.095 - 47'	0000 930 2338
.095 - 1/2 LB	0000 930 2339
.095 - 1 LB	0000 930 2340
.095 - 3 LB	0000 930 2246
.095 - 5 LB	0000 930 2247
.105 - 32'	0000 930 2341
.105 - 1 LB	0000 930 2343
.105 - 3 LB	0000 930 2227
.105 - 5 LB	0000 930 2289
.130 - 22'	0000 930 2345
.130 - 1 LB	0000 930 2347
.130 - 5 LB	0000 930 2290
.160 - 1 LB	0000 930 3607
.160 - 3 LB	0000 930 3603

QUIET LINE, ROUND	PART #
.065 - 65'	0000 930 2415
.080 - 50'	0000 930 2416
.080 - 1/2 LB	0000 930 2418
.095 - 47'	0000 930 2419
.095 - 1/2 LB	0000 930 2420
.095 - 1 LB	0000 930 2421
.095 - 3 LB	0000 930 2535
.160 - 1 LB	0000 930 3708
.105 - 3 LB	0000 930 2414



PRE-CUT LINE FOR DUROCUT LINE HEADS

DuroCut Line .80 (L) / Package of 48
0000 930 3503

DuroCut Line .120 (XL) / Package of 48
0000 930 3504

DuroCut Line .160 (XXL) / Package of 48
0000 930 3505



STIHL POLYCUT™ BLADES

Set of 25 replacement blades for all STIHL PolyCut™ heads 5-3 to 41-3.

4111 007 1001

Set of 8 replacement blades for STIHL PolyCut™ heads 2-2 and 3-2.

4008 007 1000

Set of 12 replacement blades for STIHL PolyCut heads 6-2 and 18-2.

4002 007 1020



BLADE SET TOOL

Used to adjust chisel tooth circular saw blades.

4020 893 5000



PRE-CUT LINE FOR FIXCUT™ LINE HEADS

0.095 / Package of 100
0000 930 2311

0.130 / Package of 100
0000 930 2313



ACCESSORIES FOR BRUSHCUTTERS & CLEARING SAWS

STIHL accessories can make all the difference during particularly lengthy jobs. Harnesses help relieve back fatigue while other accessories turn the STIHL machine into an integrated system.

UNIVERSAL TRIMMER STRAP

Single shoulder strap.

For FS 38 - 70, HL, HT
7002 200 0055

For FS 90 - 250
4119 710 9012



DOUBLE HARNESS

For FS 56 - FS 240

Trimmer and brushcutter harness.

4119 710 9001



NEW ADVANCE X-FLEX FS SET

For FS 56 - 561

Set consists of the Advance X-Flex hip belt (size M) and Advance X-Flex FS Harness (size M-L).

0000 007 4802



XTREEM HARNESS

For FS 91 - 561

Our most advanced clearing saw harness for professional users. Wide range of adjustment and features outstanding comfort. Convenient replaceable hook for quick release of power tool.

0000 710 9001



ADVANCE PLUS HARNESS

For FS 91 - 561

Brushcutter and clearing saw harness for professional users. Features replaceable hook that allows simple and quick connection/disconnection of the power tool.

4147 710 9015



UNIVERSAL ADVANCE HARNESS

For FS 56 - 561

Comfortable harness used for a variety of mowing applications. Hook pad allows for easy connection of outdoor power tool.

Large 4147 710 9002
XXL 4147 710 9004



NEW ADVANCE X-FLEX FS HARNESS

For FS 56 - 561

Shoulder harness with high-visibility orange, support cushion with comfort hook and side cushion for weight compensation.

Small 0000 790 4401
M-L 0000 790 4402



GRASS BLADE KIT

For converting a loop handle ("R") unit from line head to grass blade application. Blade sold separately.

For FS 55 / 90 / 100 / 110 / 130 / 250 "R"
4180 007 1013

For FS 56 / 70 "R"
(high arc loop handle version)
4144 007 1014

For FS 56 / 70 "R"
(low-profile loop handle version)
4144 007 1016

For FS 91 / 111 / 131 / 240 "R"
4180 007 1032



UNIVERSAL GUARD

For FS 55-250, KM 55-110
4119 007 1027

For FS 500 / 550 / 560
4116 007 1020



BLADE GUARD KIT FOR CIRCULAR SAW BLADES

For securing and transporting units equipped with a metal blade. Blade sold separately.

200 MM - for FS 90 / 110 / 130 / 250
4126 007 1002

200 MM - for FS 91 / 111 / 131 / 240
4180 007 1039

225 MM - for FS 220 / 280 / 360 / 420 / 500 / 550 / 560
4116 710 8201

225 MM - for FS 160 / 180 / 220 / 350 / 400 / 450 / 480
4000 713 3300

250 MM - for FS 360 / 420 / 500 / 550 / 560
4116 710 8206

250 MM - for FS 561
4000 713 4204

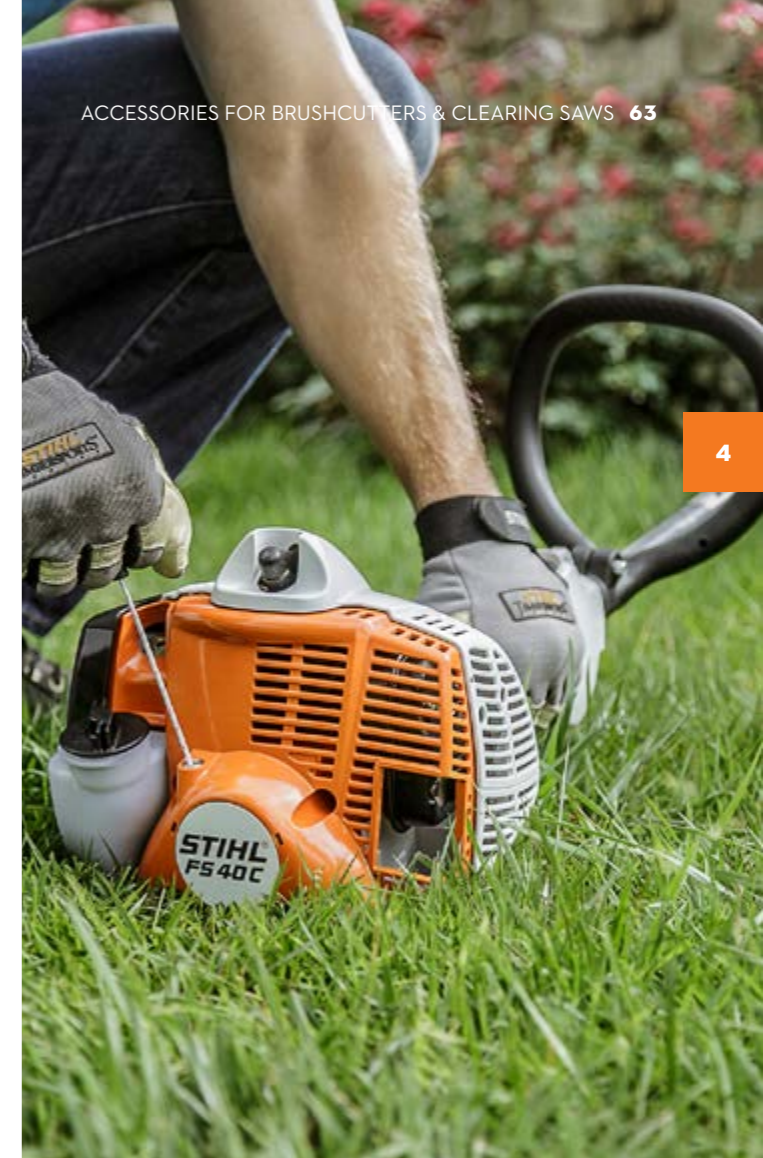

SHREDDER GUARD

320 MM - for FS 500 / 550
4116 710 8103

320 MM - for FS 560
4148 710 8103

ACCESSORIES FOR BRUSHCUTTERS & CLEARING SAWS

Having the proper tool for the job can make all the difference, and STIHL has a cutting head or blade appropriate for even the most challenging landscaping and forestry jobs.

MOWING HEADS & CUTTING TOOLS

STIHL mowing heads can be used on the smallest electric trimmer as well as on the largest clearing saw. The thickness of the nylon line varies, depending on the performance class and operating conditions. The nylon is colour-coded so that the thickness of the line can be determined more easily.



THREADING THE NYLON LINE ON AUTOCUT® HEADS (C MODELS)*

A new nylon line can be pulled in from the outside without opening the mowing head. Insert one or two nylon lines into the mounting hole and then coil the lines by turning them.

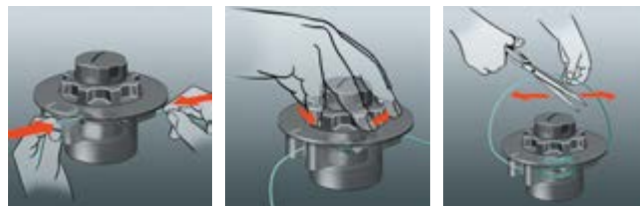

* Pictures illustrate AutoCut® C 6-2.



AUTOCUT® LINE HEADS

Semi-automatic head, double-line for cutting and trimming. Greater convenience when refilling with nylon line.

- | | |
|--|--|
| AutoCut® head C 3-2
4009 710 2100 | AutoCut® head 2-2
4008 710 2103 |
| AutoCut® head C 4-2
4006 710 2121 | AutoCut® head 25-2
4002 710 2108 |
| AutoCut® head C 6-2
4006 710 2126 | NEW AutoCut® head 27-2
4002 820 2302 |
| AutoCut® head C 26-2
4002 710 2169 | AutoCut® head 36-2
4002 710 2170 |



DUROCUT LINE HEADS

High durability as well as easy to load and mount. Smooth cutting due to large contact surface.

- | |
|---|
| DuroCut head 5-2
4006 710 2131 |
| DuroCut head 20-2
4002 710 2182 |
| DuroCut head 40-4
4005 710 2114 |



POLYCUT™ MOWING HEADS

The large diameter of the cutting circle allows for efficient, high performance mowing. The PolyCut™ mowing head offers the flexibility of using pieces of trimmer line instead of the regular blades. High durability as well as easy to load and mount. Smooth cutting due to large contact surface.

- | | |
|--|---|
| PolyCut™ mowing head 2-2
4008 710 2102 | PolyCut™ mowing head 28-2
4002 820 2300 |
| PolyCut™ mowing head 3-2
4009 710 2104 | PolyCut™ mowing head 48-2
4003 710 2126 |
| PolyCut™ mowing head 5-3
4004 710 2180 | NEW PolyCut™ mowing head 18-2
4002 820 2302 |
| PolyCut™ mowing head 6-2
4006 710 2137 | |

CUTTING AROUND OBSTACLES



STIHL SUPERCUT™ HEAD
Two lines, for mowing and clearing work. Mowing lines are automatically adjusted for optimal cutting length.



AUTOCUT® HEAD
Two lines or four lines, for mowing and clearing work. Mowing lines are automatically extended by tapping the mowing head on the ground.



TRIMCUT™ HEAD
Two lines, for mowing and clearing work. Mowing lines are extended by hand.



DUROCUT HEAD
Two or four lines, for mowing and thinning work, even on tough grass. Up to four lines can be easily inserted.

SMALL WEEDS



STIHL POLYCUT™ HEAD
Two lines, for mowing and clearing work. Mowing lines are automatically adjusted for optimal cutting length.



AUTOCUT® HEAD
Two lines or four lines, for mowing and clearing work. Mowing lines are automatically extended by tapping the mowing head on the ground.



TRIMCUT™ HEAD
Two lines, for mowing and clearing work. Mowing lines are extended by hand.



DUROCUT HEAD
Two or four lines, for mowing and thinning work, even on tough grass. Up to four lines can be easily inserted.

LARGE WEEDS



STIHL POLYCUT™ HEAD
Universal cutting tool for trimming and working on large areas. With two plastic blades.



METAL BLADE
Steel, with 2 cutters. For working on large areas of tough grass.



METAL BLADE
Steel, with 4 cutters. For working on large areas of tough grass.



METAL BLADE
Steel, with 8 cutters. For cutting thick dry weeds and reeds.

REEDS AND BUSHES



METAL BLADE
Steel, with 8 cutters. For cutting thick dry weeds and reeds.



BRUSH KNIFE
Steel, for trimming and removing tough, tangled grass and scrub; can also be used to trim thorny bushes.



SHREDDER KNIFE
Steel, for trimming and removing tough, tangled grass and scrub. Particularly good at trimming thorny bushes.



CIRCULAR SAW BLADE, SCRATCHER TOOTH
Special steel tool for brushcutters from the middle range upwards. For gnarled bushes and thin tree trunks.

BUSHES AND SMALL DIAMETER TREES



CIRCULAR SAW BLADE, CHISEL TOOTH
Special steel tool for brushcutters from the middle range upwards. For sawing and clearing.



CIRCULAR SAW BLADE, SCRATCHER TOOTH
Special steel tool for brushcutters from the middle range upwards. For gnarled bushes and thin tree trunks.



CIRCULAR SAW BLADE, MAXI BLADE
Special steel tool for large clearing saws. Cutting trees, thinning and trimming.



HIGH PERFORMANCE BLADE
Cuts 20% faster than regular circular blades.

	Displacement (CC)	Power output (KW/HP)	Weight (LB) Ⓞ	Engine type	Overall length without cutting tool	Cutting tool	Tank capacity Ⓞ	Antivibration system	4-point anti-vibration system	Low-emission engine	Elastostart™	Easy2Start™ (E)	Multi-function handle	Loop handle	Bike handle	Handle adjustment without tools	Harness	Strap	Goggles	Sound pressure level DB(A)	Vibration level left/right (M/S ²)	Gearhead angle	Shaft diameter	Fuel delivery
TRIMMERS																								
FS 38	27.2	0.65/0.87	9.2	Stratified Scavenging	1.47	AutoCut® C 6-2	0.33	-	-	-	○	-	●	-	-	-	-	○	●	-	-	-	-	-
FS 40 C-E	27.2	0.7/0.94	9.9	Stratified Scavenging	1.45	AutoCut® C 6-2	0.34	-	-	●	○	●	-	●	-	-	-	○	●	-	-	-	-	-
FS 50 C-E	27.2	0.8/1.07	10.1	Stratified Scavenging	1.65	AutoCut® C 6-2	0.34	-	-	●	-	●	-	●	-	-	-	○	●	-	-	-	-	-
BRUSHCUTTERS WITH LOW-EMISSION ENGINES																								
FS 56 RC-E	27.2	0.8/1.07	10.6	Stratified Scavenging	1.7	AutoCut® 25-2	0.34	-	-	●	○	●	-	●	-	-	-	●	●	-	-	-	-	-
FS 56 C-E	27.2	0.8/1.07	11.5	Stratified Scavenging	1.7	AutoCut® 25-2	0.34	-	-	●	○	●	-	-	●	-	-	●	●	-	-	-	-	-
FS 70 R	27.2	0.9/1.2	10.4	Stratified Scavenging	1.7	AutoCut® 27-2	0.64	●	-	●	-	-	●	●	-	-	●	-	●	-	-	-	-	-
FS 91 R	28.4	0.95/1.27	12.1	4-MIX™	1.8	AutoCut® 25-2	0.53	●	-	●	●	-	●	●	-	-	●	-	●	-	-	-	-	-
FS 91	28.4	0.95/1.27	12.8	4-MIX™	1.8	AutoCut® 26-2	0.53	●	-	●	●	-	●	-	●	●	●	-	●	-	-	-	-	-
FS 94 R	24.1	0.9/1.2	10.1	Stratified Scavenging	1.78	AutoCut® 26-2	0.54	●	-	●	-	-	●	●	-	-	●	-	●	-	-	-	-	-
FS 111 RX	31.4	1.05/1.4	11.0	4-MIX™	1.8	AutoCut® 26-2	0.53	●	-	●	○	-	●	●	-	-	●	-	●	-	-	-	-	-
FS 111 R	31.4	1.05/1.4	12.1	4-MIX™	1.8	AutoCut® 26-2	0.53	●	-	●	○	-	●	●	-	-	●	-	●	-	-	-	-	-
FS 111	31.4	1.05/1.4	12.8	4-MIX™	1.8	AutoCut® 26-2	0.53	●	-	●	○	-	●	-	●	●	●	-	●	-	-	-	-	-
FS 131 R	36.3	1.4/1.9	12.1	4-MIX™	1.8	AutoCut® 26-2	0.53	●	-	●	○	-	●	●	-	-	●	-	●	-	-	-	-	-
FS 131	36.3	1.4/1.9	12.8	4-MIX™	1.8	AutoCut® 26-2	0.53	●	-	●	○	-	●	-	●	●	●	-	●	-	-	-	-	-
POWERFUL BRUSHCUTTERS																								
FS 240 R	37.7	1.7/2.3	14.6	Stratified Scavenging	1.87	AutoCut® 26-2	0.75	●	-	●	●	-	●	●	-	-	●	-	●	-	-	-	-	-
FS 251	41.6	2.0/2.7	15.2	Stratified Scavenging	1.87	AutoCut® 27-2	0.72	●	-	●	●	-	●	-	●	-	●	-	●	-	-	-	-	-
FS 251 R	41.6	2.0/2.7	14.6	Stratified Scavenging	1.87	AutoCut® 27-2	0.72	●	-	●	●	-	●	●	-	-	●	-	●	-	-	-	-	-
FS 261	41.6	2.0/2.7	17.2	Stratified Scavenging	1.87	AutoCut® 26-2	0.75	●	-	●	●	-	●	-	●	●	●	-	●	-	-	-	-	-
PROFESSIONAL CLEARING SAWS																								
FS 361 C-EM	37.7	1.7	19.0	Stratified Scavenging	1.79	4119 713 4200 200MM Circular Saw Blade	0.75	-	●	●	-	●	-	-	●	●	Forestry Advance	-	-	99	2.2/1.8	35	28	STIHL M-Tronic™
FS 460 C-EM K	45.6	2.2	18.7	Stratified Scavenging	1.68	4000 713 4201 Maxi Blade	0.75	-	●	●	-	●	-	-	●	●	Xtream Advance	-	-	100	2.4/2.0	25	28	STIHL M-Tronic™
FS 561 C-EM	57.1	2.8	22.7	Stratified Scavenging	1.76	4000 713 4201 Maxi Blade	0.99	-	●	●	-	●	-	-	●	●	Xtream Advance	-	-	104	3.3/3.3	35	38	STIHL M-Tronic™

- Standard
- Can be retrofitted (special accessory)
- Ⓞ Without fuel, cutting attachment or deflectors.
- Conversion Formula kW x 1.341 = bhp (ch)
- C** Comfort
- K** Short shaft
- R** Loop handle
- E** Easy2Start™

Note: Specifications are as of January 1, 2024. For most recent updates, visit www.stihl.ca. Models and specifications are subject to change without notice. Manufacturer reserves the right to change appearance, function and components of any STIHL product without prior notice or liability.

VERSATILITY COMES STANDARD.

70 ABOUT THE KOMBISYSTEM

76 YARD BOSS®

72 KOMBIENGINES

78 YARD BOSS® ATTACHMENTS AND ACCESSORIES

74 KOMBITOOLS



5 POWERFUL ENGINES



15 VARIOUS PROFESSIONAL GRADE KOMBITOOLS*



*NOT ALL COMBINATIONS ARE RECOMMENDED ON CONSUMER MODELS. PLEASE ASK YOUR STIHL DEALER.



KOMBIENGINES

Tackle numerous tasks without having to store bulky equipment. Choose one of five powerful engines, then select the appropriate KombiTools to create a custom lawn care system.



KM 56 RC-E

27.2 cc • 0.8 kW • 9.5 lb ④

Features STIHL Easy2Start™ and a powerful low-emission and fuel-efficient engine.



KM 91 R

28.4 cc • 0.95 kW • 9.7 lb ④

Powered by a proven STIHL 4-MIX™ engine designed for demanding professional use. Updates include a larger fuel tank for 30% longer runtimes along with improved handling and control.



KM 94 R

24.1 cc • 0.9 kW • 8.8 lb ④

This lightweight stratified charge engine features innovative ECOSPEED throttle control, allowing the user to set the most effective speed for a particular job and attachment.



KM 111 R

31.4 cc • 1.05 kW • 9.7 lb ④

The upgraded professional 4-MIX™ unit with low-exhaust emissions. Updates include a larger fuel tank for 30% longer runtimes along with improved handling and control.



KM 131 R

36.3 cc • 1.4 kW • 9.7 lb ④

STIHL's most powerful 4-MIX™ professional use low-emission engine in the KombiEngine line-up. Upgrades include a larger fuel tank for 30% longer runtimes along with improved handling and control.



	Displacement (CC)	Power output (KW)	Weight (LB) ④	Length to coupling sleeve (CM)	Low-emission	Strap	BG air volume at nozzle (CFM)	BG air velocity at nozzle (MPH)
KOMBIENGINES								
KM 56 RC-E	27.2	0.8	9.5	84.0	●	●	533	139
KM 91 R	28.4	0.95	9.7	92.0	●	●	536	141
KM 94 R	24.1	0.9	8.8	92.0	●	●	490	130
KM 111 R	31.4	1.05	9.7	92.0	●	●	556	145
KM 131 R	36.3	1.4	9.7	92.0	●	●	603	157

● Standard

④ POWERHEAD WEIGHTS DO NOT INCLUDE FUEL OR ATTACHMENT.

Note: STIHL KombiEngines and STIHL KombiTools are sold separately.

Note: Specifications are as of January 1, 2024. For most recent updates, visit www.stihl.ca. Models and specifications are subject to change without notice. Manufacturer reserves the right to change appearance, function and components of any STIHL product without prior notice or liability.

KOMBITOOLS

Diverse landscapes and plants impose many different types of demands with regard to the capabilities of a power tool. Practically all challenges associated with regular yard maintenance are confronted head on by the STIHL KombiSystem.



KB-KM BRISTLE BRUSH

Firm bristles get dirt out of deep grooves and crevices. The dirt is carried forward by the counter rotation of the brush.

4601 740 4905



KW-KM STIHL POWERSWEEP™

For quick and convenient clearing of dirt, fallen leaves, snow and all kinds of debris. Particularly good at removing small stones from grass.

4601 740 4904



BG-KM BLOWER

With this powerful blower attachment, you will find your KM unit the most versatile and useful piece of equipment in your yard maintenance arsenal.

4606 740 5000



HT-KM POLE PRUNER

With both feet firmly on the ground, pruning trees becomes easier and safer.

4182 200 0211



FBD-KM BED REDEFINER

The blade is designed to re-shape or re-define an existing garden bed. Ruggedly constructed for maximum durability.

4180 740 5001



RG-KM WEEDER

The RG-KM KombiTool easily removes grass and weeds from a wide variety of surfaces. The attachment consists of an upper and lower blade that operates much like a hedge trimmer. The cutting action of the weeder reduces the probability of kicking up objects, thus reducing the risk of damage or injury.

4180 740 5006



HL-KM HEDGE TRIMMER 0°

The HL-KM is designed for professional use, ideal for trimming tall or wide hedges.

4243 740 5000



HL-KM HEDGE TRIMMER 145°

Has the added flexibility of being able to be adjusted 270° (145° working range).

4243 740 5003



FH-KM POWER SCYTHE 0-135°

Trim ground level plants with ease. Gear head is equipped with stainless steel plate to protect against wear.

4243 740 5006



FS-KM MOWING HEAD

Ideal for cutting grass and trimming along walls or fences, under hedges or beside borders (with mowing head).

4180 200 0474



BF-KM SOIL CULTIVATOR

A useful tool to maintain flower beds and for weed control in gardens.

4601 740 5000



FSB-KM CURVED SHAFT TRIMMER

For those who prefer a curved-shaft trimmer. Not recommended for battery tools.

4137 740 5008



FS-KM METAL BLADE

Used for mowing heavy grass and weeds. Not for trimming around obstacles.

4180 200 0478



FCB-KM CURVED LAWN EDGER

Ideal for accurately maintaining lawn edges along paths, driveways or flower beds.

4180 740 5002



FCS-KM LAWN EDGER

Straight-shaft edger delivers more power to the cut. Depth control wheel, as well as open guard design.

4180 740 5008



KM EXTENSION

Extension for pole pruner and hedge trimmer KombiSystem attachments. Extends shaft by 39" for more reach.

ALUMINUM
4140 710 7131

CARBON FIBRE
0000 710 7102



YARD BOSS®

The STIHL YARD BOSS® comprises a powerful drive unit, frame and comes standard with a pick tine attachment. It folds up quickly and compactly for storage or transportation. The housing of impact-resistant materials is robust, lightweight and durable. The controls are conveniently positioned for easy operation, making the YARD BOSS® easy-to-guide and control.



MM 56 C-E

27.2 cc • 0.85 kW • 18.3 lb ©

Easy 2 Start™

The MM 56 C-E YARD BOSS® is an easy-to-use, multi-tasking tool equipped to meet specific property needs. It comes standard as a cultivator and easily transitions to any of its eight optional attachments.

YARD BOSS® ATTACHMENTS & ACCESSORIES

Whatever the task at hand - be it removing moss, aerating the lawn, loosening the soil or sweeping paths and courtyards - the YARD BOSS® has the ideal tool for the job. The YARD BOSS® attachments can be replaced without difficulty and without the need for special tools. As a result, the system can be easily cleaned and immediately ready for many different applications.



FS-MM TRIMMER

Quickly mow and trim with this straight shaft trimmer equipped with an AutoCut® 25-2 head.

4601 740 4610



RL-MM AERATOR

Designed to uniformly perforate the surface of the lawn allowing air, moisture and nutrients to get to the roots.

4601 740 4600



FC-MM EDGER

Bed and sidewalk edger. Designed to cut a defined edge of lawn or to cut patches of lawn to be transplanted.

4601 740 4603



BF-MM PICK TINES

Even hard or heavy soil is broken up easily. Designed to loosen soil in preparation for planting.

4601 740 4605



BK-MM BOLO TINES

An alternative to the pick tines, this design is ideal for spreading fine sandy soil, as well as, loosening soil between rows in the garden.

4601 740 4606



MF-MM DETHATCHER

Removes moss and matted growth from the surface of the lawn quickly and thoroughly. Complete with guard extension and apron.

4601 740 4607



KB-MM BRISTLE BRUSH

Thoroughly removes dirt embedded in paved areas or uneven natural stone surfaces. Complete with guard extension.

4601 740 4608



KW-MM STIHL POWERSWEEP™

Effortlessly removes dirt and rubble, sand and gravel, wet leaves and snow. Ideal for sweeping walkways and roads.

4601 740 4604

OPTIONAL ACCESSORIES



MM DEPTH GAUGE

Varies the working depth and speed when cultivating the soil by lightly lifting or lowering the tool out of or into the soil.

4601 740 4800



MM WHEEL KIT

Allows the tool to be lifted slightly, thus reducing the resistance due to friction when brushing and sweeping. Improves manoeuvrability.

4601 007 1008



MM WEIGHT- KIT

STIHL optional weight kit enhances the YARD BOSS® performance when used with the tiller attachment. Increases the pressure on the tool and ensures better depth penetration in the ground. Weighs 4.0 kg (8.8 lb).

4601 730 4500



A HEDGE FUND WITH GUARANTEED RETURN.

82 HEDGE TRIMMERS

84 LONG-REACH HEDGE
TRIMMERS

85 OVERVIEW OF HEDGE
TRIMMERS & LONG-REACH
HEDGE TRIMMERS

HEDGE TRIMMERS

STIHL hedge trimmers are designed and built for use in park and landscape maintenance, but can also be used for a variety of jobs around the home. Characterized by their durability and geared towards continuous use, their technical refinements take the strain out of your work.



HS 45

27.2 cc • 0.80 kW • 18" • 10.4 lb ⓘ

Lightweight introductory model for garden trimming. Cutter design with integrated blade guard ensures precise trimming with smooth, clean lines.



HS 46 C-E

21.4 cc • 0.65 kW • 22" • 9.5 lb ⓘ

This lightweight model makes trimming hedges easy. Features Easy2Start™ system and delayed stratified scavenging engine technology.



HS 56

21.4 cc • 0.65 kW • 9.9 lb ⓘ

The HS 56 hedge trimmer is the ideal balance of power and portability for professional users. Its 24" cutting blade is supported by a remarkably lightweight design, adding comfort and control to those extended cutting and pruning jobs.

HS 56 - 24"

ⓘ WEIGHT WITHOUT FUEL.

Note: STIHL recommends the use of fuel with no more than 10% Ethanol content. Using fuel with greater than 10% Ethanol content may cause damage to your equipment and may void your STIHL warranty.



HS 82 R & HS 82 T

HS 82 R 22.7 cc • 0.7 kW • 24" • 11.9 lb ⓘ

HS 82 T 22.7 cc • 0.7 kW • 30" • 11.7 lb ⓘ

This professional unit comes with the latest in STIHL technology. Equipped with stratified scavenging engine technology that reduces fuel consumption by 20% and fulfills all emission regulations, long-life air filter for prolonged engine protection, double-sided, sharpened cutting blades for a high quality cut, adjustable multi-function handle and a tool-less fuel cap.



R VERSION BLADE



T VERSION BLADE

R VERSION BLADE DESIGNED FOR REJUVENATING AND HEAVY PRUNING.
T VERSION BLADE DESIGNED FOR TRIMMING AND SCULPTING.



THE HS 82'S REAR HANDLE ROTATES TO 3 ADJUSTABLE POSITIONS FOR ADDED COMFORT.



LONG-REACH HEDGE TRIMMERS

Whip high or particularly wide hedges into shape without the need for scaffolding or working platforms. STIHL's long-reach hedge trimmers are designed to reach areas where a classic hedge trimmer cannot.



HL 91 K (0°)

24.1 cc • 0.9 kW • 66.9" • 11.7 lb ①

Easy to operate, the HL 91 K (0°) features a powerful, fuel-efficient, low-emission engine. Its compact design provides excellent manoeuvrability and includes an innovative ergonomic rubberized control handle with ECOSPEED throttle control, allowing for variable speed regulation. This convenient tool is designed to help professionals work longer with reduced fatigue.



HL 94 (0-145°)

24.1 cc • 0.9 kW • 95.2" • 13.6 lb ①

The lightweight professional HL 94 extended reach articulating hedge trimmer, powered by the fuel-efficient, low-noise STIHL 2-MIX engine with ECOSPEED, features a 145° adjustable head working range. The head also folds flat for transport and storage convenience.

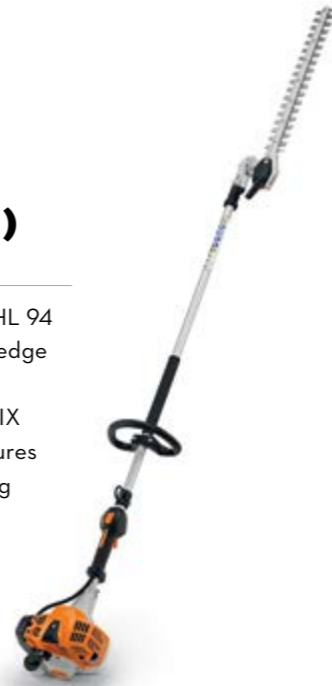

① WEIGHT WITHOUT FUEL.



	Displacement (CC)	Power output (KW)	Weight (LB) ①	Blade speed (strokes per minute)	Overall length (IN)	Cutter bar (IN)	Anti-vibration system	Elastostart™	Easy2Start™ (E)	Shoulder strap
HEDGE TRIMMERS										
HS 45	27.2	.80	10.4	3800	37.4	18	●	●	-	-
HS 46 C-E	21.4	.60	9.5	3600	39.4	22	●	-	●	-
HS 56	21.4	.65	9.9	3600	40.9	24	●	-	-	-
HS 82 R	22.7	.70	11.9	3100	47.4	24	●	●	-	-
HS 82 T	22.7	.70	11.7	5000	47.6*	24' 30*	●	●	-	-
LONG-REACH HEDGE TRIMMERS										
HL 91 K (0°)	24.1	.90	11.9	4100	66.9	24	●	-	-	●
HL 94 (0-145°)	24.1	.90	13.6	3615	95.2	24	●	-	-	●

- Standard
- ① Weight without fuel
- * With 24" cutter
- ‡ HS 82 T - 30"
- E Easy2Start™

Conversion Formula kW x 1.341 = bhp (ch)

Note: Specifications are as of January 1, 2024. For most recent updates, visit www.stihl.ca. Models and specifications are subject to change without notice. Manufacturer reserves the right to change appearance, function and components of any STIHL product without prior notice or liability.

THE WIND AT YOUR BACK.

88 **HANDHELD BLOWERS
& ACCESSORIES**

91 **BACKPACK BLOWERS
& SPRAYERS**

90 **SHREDDER VACS/BLOWERS
& ACCESSORIES**

94 **OVERVIEW OF BLOWERS,
VACUUM SHREDDERS
& SPRAYERS**

HANDHELD BLOWERS

STIHL blowers effortlessly clear paths, flower beds and lawn clippings. Built-in mufflers noticeably reduce the engine noise.



BG 50

27.2 cc • 0.7 kW • 412 cfm* • 7.9 lb ①

Get superior performance from the BG 50 gasoline-powered handheld blower. Its lightweight, compact design features a fuel-efficient engine, tool-less air filter access and an upright fuel tank for easier filling. Clean-up yard waste and leaf piles quickly and easily with this affordable and convenient blower.

*With round nozzle.



BG 56 C-E

27.2 cc • 0.7 kW • 412 cfm* • 9.3 lb ①

Great for homeowners looking to quickly clear leaves and clippings. Has adjustable locking blower tubes. Round nozzle increases air volume. Good power-to-weight ratio. Features our low-emission stratified scavenging engine and the STIHL Easy2Start™ system, making starting virtually effortless.

*With round nozzle.



BG 66 LOW NOISE

27.2 cc • 0.6 kW • 371 cfm* • 9.7 lb ①

This low-noise model features anti-vibration technology to enjoy longer, quieter operation. Features our low-emission, stratified scavenging engine.

*With round nozzle.



BG 86

27.2 cc • 0.8 kW • 444 cfm* • 9.7 lb ①

The powerful velocity, along with a comfortable anti-vibration system and both round and jet nozzles makes this professional blower ideal for large areas. Features our low-emission, stratified scavenging engine.

*With round nozzle.



BG 56/BG 66/BG 86 VACUUM KIT

4241 700 2200



BG 55/BG 65/BG 85 VACUUM KIT

4229 007 1000



ROUND NOZZLE ALSO INCLUDED.

① WEIGHT WITHOUT FUEL.

Note: STIHL recommends the use of fuel with no more than 10% Ethanol content. Using fuel with greater than 10% Ethanol content may cause damage to your equipment and may void your STIHL warranty.

GUTTER ATTACHMENT



Series of plastic tubes extend to more than 10 ft. Fits most handheld blowers. For BGE 61, BGE 71, BG 56 C-E, BG 66, BG 86, SH 56 C-E, SH 86 C-E

4241 007 1003



SHREDDER VACS/BLOWERS & ACCESSORIES

STIHL vacuum shredders clear leaves and grass clippings, even in cramped areas. These machines have a robust rotor blade to reduce the volume of leaves in the bag. The supplied blower tube converts the vacuum shredder into a powerful blower with a simple screw adjustment.



Note: Gutter Attachment in image sold separately.



SH 56 C-E

27.2 cc • 0.7 kW • 412 cfm* • 11.5 lb ①

Easy 2 Start™

Suitable for work around the home or job site, the SH 56 C-E has everything. Get the job done with lower vibrations, lower fuel consumption and lower noise levels. Features our low-emission, stratified scavenging engine and Easy2Start™ system.

*With round nozzle.



SH 86 C-E

27.2 cc • 0.8 kW • 444 cfm* • 12.3 lb ①

Easy 2 Start™

Suitable for work around the home or job site, the SH 86 C-E has everything. Get the job done with lower vibrations, lower fuel consumption and lower noise levels. Features our low-emission, stratified scavenging engine and Easy2Start™ system.

*With round nozzle.

① WEIGHT WITHOUT FUEL.

BACKPACK BLOWERS

STIHL's line of backpack blowers will blow you away with their power, performance and comfort. STIHL 4-MIX™ backpack blowers have set the standard in the outdoor power equipment industry.



BR 200

27.2 cc • 0.8 kW • 400 cfm* • 12.6 lb ①

STIHL's first backpack blower designed for the homeowner. With plenty of power, the super light, fuel-efficient BR 200 blower will get your yard work done quickly and easily.

*With round nozzle.



BR 350

63.3 cc • 2.1 kW • 436 cfm* • 22.0 lb ①

Powerful, professional, yet quiet backpack blower featuring rugged construction and a fuel-efficient, low-emission, stratified scavenging engine. The BR 350 delivers professional results at an exceptional value.

*With round nozzle.

① WEIGHT WITHOUT FUEL.

Note: STIHL recommends the use of fuel with no more than 10% Ethanol content. Using fuel with greater than 10% Ethanol content may cause damage to your equipment and may void your STIHL warranty.



BR 450

63.3 cc • 2.9 kW • 642 cfm* • 23.4 lb ①

The BR 450 is a high performance machine that produces plenty of blowing power for those tougher jobs. With a tool-less, fully adjustable blower tube and control handle, the BR 450 offers optimized ergonomics for prolonged use. Perfect for removing grass and hedge clippings, leaves or rubbish.

*With round nozzle.



BR 500 LOW NOISE

64.8 cc • 2.0 kW • 544 cfm* • 22.3 lb ①

The operating noise of this low-emission engine is only 65 dB(A) setting standards in the industry for a powerful yet 'low-noise' blower. Particularly suitable for working in noise-sensitive areas. Features high air throughput and anti-vibration system.

*With round nozzle.



BR 800 X

79.9 cc • 3.2 kW • 912 cfm* • 23.2 lb ①

The BR 800 X offers a lighter, more affordable option than the BR 800 C-E for users who need maximum power to tackle large properties.

*With round nozzle.



BR 800 C-E

79.9 cc • 3.2 kW • 912 cfm* • 25.8 lb ①

The most powerful backpack blower in the STIHL line-up, the BR 800 C-E stands up to the toughest heavy-duty professional clean-up tasks. This unit comes with the comfort start feature for easy starting for your back.

*With round nozzle.



BR 600

64.8 cc • 2.8 kW • 677 cfm* • 21.6 lb ①

The extremely powerful BR 600 can handle the toughest cleaning jobs in record time. It also sets out to impress with maximum ergonomic comfort and optimal environmental features. Canada's best selling backpack blower!

*With round nozzle.



BR 700

64.8 cc • 2.8 kW • 912 cfm* • 23.4 lb ①

This high-output blower is one of the most powerful blowers in our professional range while reducing bottom-line costs with its fuel-efficient engine.

*With round nozzle.



SR 200

27.2 cc • 0.8 kW • 10 L • 29.5 ft • 18.7 lb ①

Lightweight and ergonomic backpack sprayer, for crops up to 2.5 m in height. The SR 200 features a low-exhaust-emission, fuel-efficient engine that delivers up to 20% better fuel economy than most 2-stroke engines.



SR 450

63.3 cc • 2.9 kW • 14 L • 43 ft v / 48 ft h • 27.3 lb ①

This powerful backpack sprayer for farm or professional use features a low-emission, fuel-efficient stratified charge engine. It easily converts from liquid sprayer to granular spreader.

	Displacement (CC)	Power output (KW/HP)	Weight (LB) ①	Air Volume air nozzle (CFM)*	Average air velocity (MPH)*	Blowing force/Newtons	Sound pressure rating (DB(A))*	Round nozzle	Flat nozzle	Single-lever cruise control	Anti-vibration system	Manual fuel primer	Easy2Start™ (E)	ElastoStart™
HANDHELD BLOWERS														
BG 50	27.2	0.7	7.9	412	134	13	70	●	-	-	-	●	-	○
BG 56 C-E	27.2	0.7	9.3	412	134	13	70	●	○	-	-	●	●	○
BG 66	27.2	0.6	9.7	371	115	10	65	●	○	-	●	●	-	○
BG 86	27.2	0.8	9.7	444	170	15	70	●	●	-	●	●	-	○
VACUUM SHREDDERS														
SH 56 C-E	27.2	0.7	11.5	412	134	13	70	●	○	-	-	●	●	○
SH 86 C-E	27.2	0.8	12.3	444	170	15	70	●	●	●	●	●	●	○
BACKPACK BLOWERS														
BR 200	27.2	0.8	12,6	400	125	12	70	●	-	●	●	●	-	-
BR 350	63.3	2.1	22.0	436	167	17	74	●	○	●	●	●	-	-
BR 450	63.3	2.9	23.4	642	186	28	77	●	○	●	●	●	-	●
BR 500	64.8	2.0	21.8	544	173	22	65	●	○	●	●	●	-	○
BR 600	64.8	2.8	20.9	677	199	32	75	●	○	●	●	●	-	○
BR 700	64.8	2.8	23.8	912	165	35	75	●	○	●	●	●	-	○
BR 800 X	79.9	3.2	23.2	912	199	41	78	●	○	●	●	●	-	○
BR 800 C-E	79.9	3.2	25.8	912	199	41	78	●	○	●	●	●	●	○
SPRAYERS														
SR 200	27.2	0.8	17.4	542	201	-	-	●	-	●	●	●	-	-
SR 450	63.3	2.9	28.2	542	201	-	-	●	-	●	●	●	-	-

- Standard
- Can be retrofitted (special accessory)
- ① Weight without fuel.

* Tested in accordance with ANSI 175.2 standard. Newton is the force needed to accelerate 1 kg of mass at the rate of 1 m/sec².

E Easy2Start™

Conversion Formula kW x 1.341 = bhp (ch)

Note: Specifications are as of January 1, 2024. For most recent updates, visit www.stihl.ca. Models and specifications are subject to change without notice. Manufacturer reserves the right to change appearance, function and components of any STIHL product without prior notice or liability.





WORKS WELL UNDER PRESSURE.

98 GAS PRESSURE WASHERS

100 PRESSURE WASHER ACCESSORIES

GAS PRESSURE WASHERS



RB 200

173 cc • 2,800 psi • 8.7 l/min • 25 ft • 3.7 kW • 62.5 lb

The RB 200 is the perfect gas pressure washer for cleaning decks, driveways and many other simple chores around the property. This unit features a maximum pressure of 2,800 psi, a high quality powder coated, 1 1/4" welded steel tube frame with folding handlebar, 12" semi-pneumatic tires and an anodized manifold.



RB 600

208 cc • 3,400 psi • 11.3 l/min • 40 ft • 5.2 kW • 118 lb

Ideal for providing maximum performance, reliability and easy maneuverability, along with a maximum pressure of 3,400 psi, the RB 600 is a great choice for homeowners and small businesses. Featuring a powder coated, 1 1/4" welded steel tube frame with folding handle bar, 13" pneumatic tires and a brass manifold.



RB 800

429 cc • 4,400 psi • 15.1 l/min • 50 ft • 10.5 kW • 168 lb

With a maximum pressure of 4,400 psi, the professional grade RB 800 is designed to handle any big project, offering maximum performance, reliability and easy maneuverability. Equipped with a professional grade 36" two piece lance with insulated trigger gun with safety lock-off and a 50 ft. wire braided high pressure hose.



RB 400 DIRT BOSS®

196 cc • 3,300 psi • 10.3 l/min • 25 ft • 4.8 kW • 90 lb

With a maximum pressure of 3,300 psi the RB 400 DIRT BOSS® is great for use around a larger property or small farm. This unit comes with 1 1/4" welded steel tube frame, 10" pneumatic wheels and a brass manifold. Like the other RB units, this unit features a folding handle design for a space saving storage solution. Comes with a 25 ft. non-kink flex and non-marking pressure hose.

	Displacement (CC)	Power Consumption/ Power Output	Weight (LB)	Water Pressure (PSI)	Water Flow (L/h)	Container capacity (LITRE)	Suction hose length (FT/M)	Power cord length (FT/M)	Sound level (DB(A))	Maximum flow rate	Maximum pressure (PSI)	High-pressure hose length (FT)
GAS PRESSURE WASHERS												
RB 200	173	3.7 kW	62.5	2,800	8.7	-	-	-	-	8.7 L/MIN	2,800	25
RB 400 DIRT BOSS®	196	4.8 kW	90.0	3,300	10.3	-	-	-	-	10.3 L/MIN	3,300	25
RB 600	208	5.2 kW	118.0	3,400	11.3	-	-	-	-	11.3 L/MIN	3,400	40
RB 800	429	10.5 kW	168.0	4,400	15.1	-	-	-	-	15.1 L/MIN	4,400	50

Note: Specifications are as of January 1, 2024. For most recent updates, visit www.stihl.ca. Models and specifications are subject to change without notice. Manufacturer reserves the right to change appearance, function and components of any STIHL product without prior notice or liability.

IMPORTANT INFORMATION

WARNING: Improper use of any power tool may cause serious or fatal injury. Read, understand and follow carefully the operating and safety instructions in your operator's manual before using these products.



GAS PRESSURE WASHER ACCESSORIES



ROTATING NOZZLE 3000 PSI

Rotating zero-degree nozzle for aggressive cleaning of stubborn stains. For RB 200 and RB 400 DIRT BOSS® only.



MULTI-FUNCTION NOZZLE

Features six spray patterns: 0°, 15°, 25°, 40° soap and rinse all in one nozzle.



ROTATING SURFACE CLEANER

Quick and easy clean-up for large surfaces. Ideal for sidewalks and driveways.



WATER BROOM

Wash large surfaces like decks, sidewalks and driveways quickly with this attachment.

GAS PRESSURE WASHER ACCESSORIES	FITS MODELS	PART NUMBER
24.6 FT HOSE EXTENSION	RB 200, 400	4925 500 0818
39.4 FT HOSE EXTENSION	RB 600	4925 500 0813
49.2 FT HOSE EXTENSION	RB 800	4925 500 0812
HIGH PRESSURE SPRAY GUN	RB 200, 400	4789 500 1301
HIGH PRESSURE SPRAY GUN W/ GRIP	RB 600, 800	4791 500 1301
19.7 FT SPRAY WAND	RB 200, 400, 600	4915 500 0939
33.5 FT SPRAY WAND	RB 200, 400, 600, 800	4915 500 0942
47.4 FT SPRAY WAND EXTENSION	RB 200, 400, 600, 800	4915 500 0301
PIVOT COUPLER	RB 200, 400, 600, 800	4789 500 6701
NOZZLES (3 PACK - 15°, 25°, 65°)	RB 200	4789 007 1007
NOZZLES (5 PACK - 0°, 15°, 25°, 40°, 65°)	RB 400	4790 007 1007
NOZZLES (5 PACK - 0°, 15°, 25°, 40°, 65°)	RB 600	4791 007 1006
NOZZLES (5 PACK - 0°, 15°, 25°, 40°, 65°)	RB 800	4792 007 1011
LONG RANGE DETERGENT NOZZLE	RB 200, 400, 600, 800	4900 502 1024
MULTI-FUNCTION NOZZLE (6 PATTERNS, 4200 PSI)	RB 200, 400, 600, 800	4900 502 1025
ROTATING NOZZLE (3000 PSI)	RB 200, 400	4900 500 1648
ROTATING NOZZLE (5100 PSI)	RB 600, 800	4900 500 1647
GUTTER CLEANER	RB 200, 400, 600, 800	4789 007 1009
WATER BROOM	RB 200, 400, 600, 800	4789 500 3901
ROTATING SURFACE CLEANER	RB 200, 400, 600, 800	4900 500 3907
PUMP CONDITIONER AND WINTERIZER	ALL PRESSURE WASHERS	7002 871 1650

A REVOLUTION IN POWER.

104 CUT-OFF MACHINE
COMMON FEATURES

110 CONCRETE CUTTER

106 CUT-OFF MACHINES

112 DRILL & AUGER

108 HEAVY DUTY CUTTING
WHEELS & MACHINE CART

113 OVERVIEW OF
CONSTRUCTION
EQUIPMENT



COMMON FEATURES OF CUT-OFF MACHINES

STIHL cut-off machines are indispensable wherever steel, concrete, stone, cast pipes, asphalt and similar materials have to be cut. Thanks to their robust engineering, there is no questioning why they are the number one selling brand of cut-off machines in the world. STIHL cut-off machines cope effortlessly with the toughest demands and stand out through their reliability and distinctly reduced maintenance and service intervals, thus significantly lowering running costs.

- A** REPLACEABLE "IN TANK" FUEL FILTER lowers cost and is easy to maintain.
- B** HEAVY-DUTY AIR FILTRATION SYSTEM The TS 410, TS 420, TS 500i, TS 700 and TS 800 feature the X2 air filtration system.
- C** AIR FILTER COVER is easy to remove for fast and easy filter replacement.
- D** UPRIGHT AND ENLARGED FUEL PORT for easy fueling.
- E** BAYONET STYLE FUEL CAP for secure fit with retainer for easy use, even with gloves on.
- F** THROTTLE TRIGGER INTERLOCK must be depressed before the trigger can be activated.
- G** PROTECTED THROTTLE TRIGGER helps prevent damage.
- H** ON/OFF SWITCH is conveniently located on top of handle and recessed to prevent accidental shutdown.
- I** SPARK PLUG is protected yet easy to change.
- J** HIGH-TECH POLYMER HOUSINGS are lightweight and corrosion-resistant.
- K** HIGH-PERFORMANCE COOLING SYSTEM for superior air flow and heat dissipation.
- L** PROTECTED DECOMPRESSION VALVE makes starting easier.
- M** 2-RING PISTONS improve engine efficiency and hold compression longer than 1-ring pistons. Also, they transfer heat from the piston to cylinder, helping the engine stay cooler and last longer.

- N** LONG-LIFE CYLINDERS give maximum wear life, superior cooling and lubrication, and more power output per cubic centimeter of engine displacement.
- O** ANTI-VIBRATION SYSTEM reduces operator fatigue.
- P** SPARK ARRESTER MUFFLER has large baffles which reduce noise level, and contains a screen designed to reduce the emission of sparks.
- Q** SEMI-AUTOMATIC BELT TENSIONER allows for easy adjustment of drive belt.
- R** REVERSIBLE CUTTING ARM lets you cut in the inboard or outboard position.
- S** WATER ATTACHMENT KIT quick coupler for connecting a standard water hose to reduce dust when cutting concrete.

ADDITIONAL FEATURES

ELECTRONIC IGNITION provides easy starting and smooth running.

INTELLICARB™ COMPENSATING CARBURETOR measures air on clean side of air filter and adjusts metering diaphragm in carburetor, maintaining optimal fuel-to-air ratio. Ensures optimal performance levels even when the air filter begins to clog.

BALANCE AND DESIGN help reduce fatigue and make handling easy.

ELECTRONIC WATER CONTROL (EWC) allows operator to easily adjust the flow of water while cutting. Available on the TS 480i and TS 500i only.



TS 420

Note: STIHL Cutquik™ cut-off machines have many common features. However, all models may not have all the features shown here. Consult your STIHL Dealer for details.



CUT-OFF MACHINES

STIHL cut-off machines are indispensable wherever steel, concrete, stone, cast pipes, asphalt and similar materials have to be cut. Thanks to their robust engineering, there is no question they are the number one selling brand of cut-off machines in the world.



TS 410 12" WHEEL

66.7 cc • 3.2 kW • 20.7 lb ©

The TS 410 features the revolutionary X2 air filtration system: one filter, one year (under recommended operating conditions). It's that simple. Vibration has been reduced by 43% over previous models with the innovative anti-vibration system and our leading-edge stratified charge technology improves fuel efficiency and increases runtime by 20%, while reducing emissions by 44%.



TS 440 14" WHEEL

66.7 cc • 3.2 kW • 24.5 lb ©

A tool for working in confined spaces. The expanded guard adjustment range of the TS 440 allows greater access in challenging cuts such as the bottom portions of walls, cutting in corners and cutting the underside of in-ground pipes. This expanded guard adjustability is made possible due to the sensor-activated STIHL Quickstop® wheel brake technology. The first cut-off machine in the world equipped with the technology capable of stopping the rotation of the cutting wheel in fractions of a second if kickback occurs.



TS 700 14" WHEEL

98.5 cc • 5.0 kW • 25.6 lb ©

The TS 700 has an extremely powerful 5.0 kW engine and it includes a long-life X2 air filtration system, ElastoStart™ plus a compensating carburetor system as standard features, as well as a water attachment. It can be operated by hand or with the FW 20 cart.



TS 420 14" WHEEL

66.7 cc • 3.2 kW • 21.2 lb ©

The TS 420 cut-off machine delivers a unique blend of performance and efficiency, helping you work longer and more comfortably with a 14" cutting wheel. It features stratified charge engine technology that cuts fuel consumption by 20% and exhaust emissions by 44%. Its lightweight assembly, anti-vibration system and long-life X2 air filtration system help to reduce maintenance.



TS 500i 14" WHEEL

72.2 cc • 3.9 kW • 22.5 lb ©

The TS 500i is designed for superior handling during the toughest jobs. Featuring the handheld outdoor power equipment industry's first electronically controlled fuel injection system, the TS 500i increases power by 17% and cutting speed by 15%, as compared to the TS 420. This low-emission fuel injected cut-off machine provides optimal torque throughout the RPM range.



TS 800 16" WHEEL

98.5 cc • 5.0 kW • 28.0 lb ©

Just like the TS 700, the TS 800 with the amazing long-life X2 air filtration system is designed for extended cutting service. It features the 5-point, dual-element vibration control system and is well-balanced. This machine does the job of other large walk-behind machines with a deep cutting 16" wheel and can be handheld or used with the FW 20 cart.



© WEIGHT WITHOUT FUEL AND CUTTING WHEEL.

Note: All models shown with optional STIHL diamond wheel and standard water attachment.

CUTTING WHEELS & CART

The effectiveness of a cut-off machine depends on the quality of the cutting wheel. For this reason, STIHL cutting wheels are manufactured to the very highest standards, delivering outstanding cutting performance and accuracy. Users can choose between composite synthetic resin wheels for cutting through rock, asphalt or steel and diamond cutting wheels for concrete, asphalt or natural stone.



WARNING

Never use carbide-tipped, wood cutting or circular saw blades on cut-off machines. They can cause severe personal injury or death from reactive forces, blade contact or thrown objects. Never cut wood of any type.

DIAMOND WHEELS

HEAVY DUTY MATERIALS

SB 90 - 12"	0835 096 7004
SB 90 - 14"	0835 096 7005
SB 90 - 16"	0835 096 7006
D-G80 - 14"	0835 070 7000



ALL PURPOSE MATERIALS

BA 90 - 12"	0835 094 7012
BA 90 - 14"	0835 094 7013
BA 80 - 16"	0835 094 7002



GENERAL CONSTRUCTION MATERIALS

B 80 - 14"	0835 090 7056
B 80 - 16"	0835 090 7057
B 10 - 12"	0835 090 7051
B 10 - 14"	0835 096 7052
B 10 - 16"	0835 096 7053
BA 10 - 12"	0835 094 7006
BA 10 - 14"	0835 094 7007
BA 10 - 16"	0835 094 7008



COMPOSITE RESIN WHEELS

Stone

K-BA - 12"	0835 020 7003
K-BA - 14"	0835 020 7001
K-BA - 16"	0835 020 7002



Steel

K-ME - 12"	0835 010 7003
K-ME - 14"	0835 010 7001
K-ME - 14"	0835 012 7001 (TS 440 Only)
K-ME - 16"	0835 010 7002



Asphalt / ductile cast iron

K-DG - 12"	0835 030 7003
K-DG - 14"	0835 030 7001
K-DG - 16"	0835 030 7002



FW 20 CART

The STIHL cut-off machine FW 20 cart for TS 410/TS 420/TS 500i/TS 700/TS 800 with a quick mounting system and convenient depth adjustment. Cutting depth can be easily adjusted via the depth control lever. Our range of accessories includes several tried and tested articles that make light work of precision tasks.

Does not include mounting kit - order mounting kit for appropriate saw.

FW 20 CART	4224 710 1403
WATER TANK	4224 007 1018



QUICK MOUNTING SYSTEM KIT

FOR TS 410, TS 420, TS 500i	4250 790 0702
FOR TS 700, TS 800	4224 790 0705

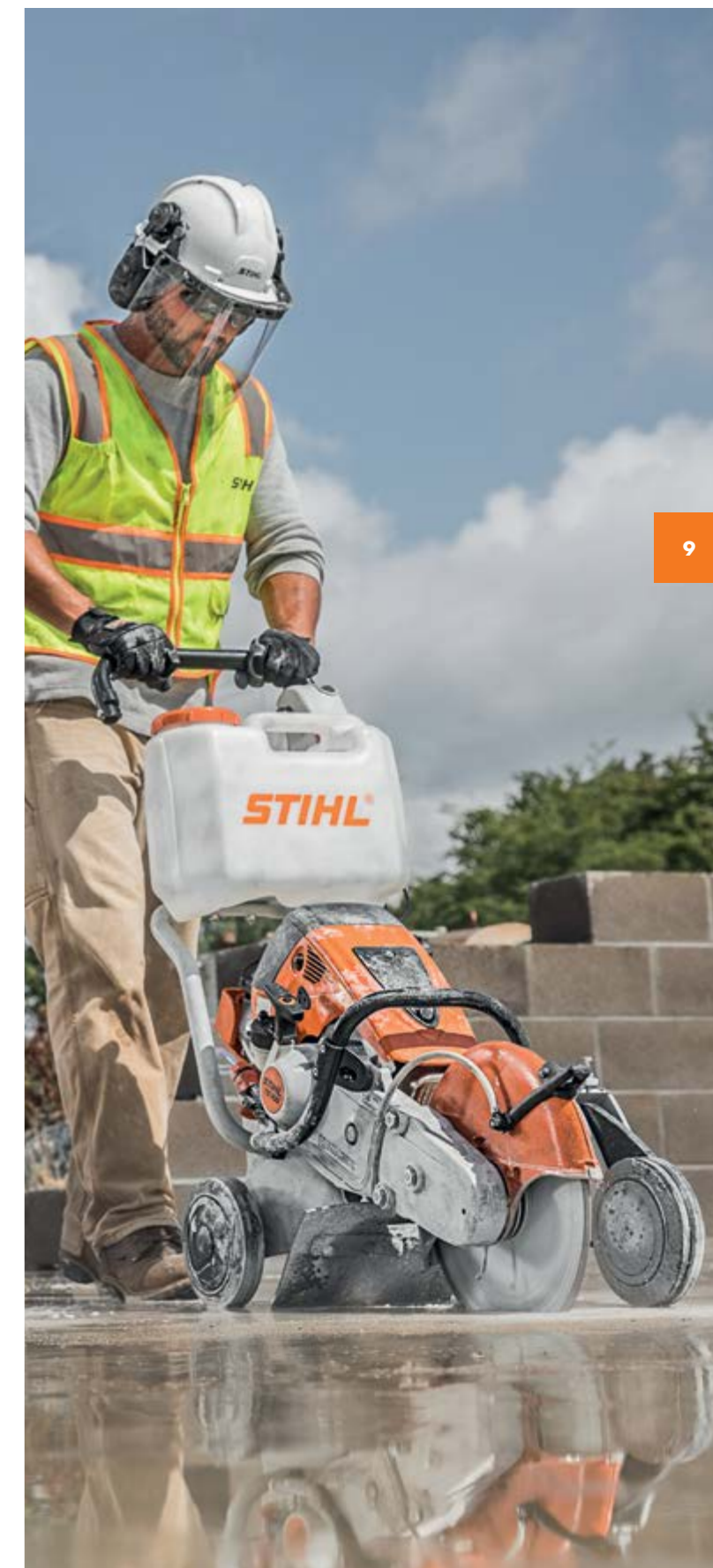

CONCRETE CUTTER



GS 461 ROCK BOSS®

76.5 cc • 4.3 kW • 5.2 nm • 16.7 lb ⑦

The GS 461 ROCK BOSS® is built for freehand cutting of construction materials, such as concrete, natural stone, building blocks, sewage pipes, water supply lines, ductile iron and general masonry. This high cutting performance concrete cutter reduces possible cutting errors and helps to save time on the construction site. Lightweight, easy handling, ergonomic design and efficient water usage are additional features.

⑦ WEIGHT WITHOUT FUEL, GUIDE BAR AND CHAIN.



WARNING

Improper use of any power tool may cause serious or fatal injury. Read, understand and carefully follow the operating and safety instructions in your operator's manual before using these products.

The GS 461 ROCK BOSS® cannot be converted to cut wood.

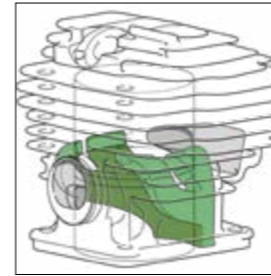

STRATIFIED CHARGE ENGINE

Modern, low-emission delayed stratified scavenging engine reduces fuel consumption by up to 20%. High torque over a wide RPM range and 30% better cutting performance compared to competitive models.



SIDE CHAIN ADJUSTER

Chain tensioning is fast and easy with an easy to mount guide bar and chain. Keeps hands safely away from the cutting attachment.



WATER HOSE CONNECTOR

Water hose connector is located directly on the saw with easy water hook-up. The valve has been slightly raised to avoid contact with the ground to avoid premature damage.



RUBBER PROTECTION OF ENGINE HOUSING

Protects the crankcase from damage and is used as a stop for boring cuts.



CHAIN SPROCKET COVER

Well-designed water circuit for efficient use of the rinsing water with strategically placed water outlets to route water to the cut. Includes side chain adjuster and captive nuts.



HD2 FILTER

The polyethylene air filter is specially designed to operate in extremely dusty conditions. The HD2 has a 70% improvement in filtration compared to a traditional paper filter. The filter element repels water, ideal for the GS 461 ROCK BOSS®. The HD2 includes an auxiliary filter to enhance performance.



16" & 18" STIHL ROLLOMATIC® G GUIDE BARS & 36 GBM DIAMOND ABRASIVE CHAIN

Easy-to-mount guide bar and chain with robust clamp stud for durability. The guide bar is designed to provide optimum water flow to the chain in order to enhance performance and prolong chain life. Pre-sharpened diamond segments; segments do not have to be sharpened during cutting.



36 GBM CHAIN

This entry-level diamond abrasive chain for the GS 461 ROCK BOSS® is an affordable alternative to the 36 GBM chain with diamond segments on every other drive link.

DRILL & AUGER

The STIHL drill & auger can be used for a variety of purposes, from drilling simple holes in the ground to taking soil samples. Holes measuring up to 10" (250 mm) in diameter can be drilled using the appropriate bit. These units can also be equipped with a bit for drilling through ice.



STIHL QUICKSTOP® AUGER BRAKE

The STIHL Quickstop® auger brake is unique in the world. It is tripped by the operator's thigh when the drill jams in the ground and brings the drill to an immediate standstill.

BT 45

27.2 cc • 0.8 kW • 10.6 kg ①

This drill comes with a powerful gas engine and various optional drill bits for drilling holes up to 1" (25 mm) in diameter. With quick-release chuck, two forward speed gearbox and reverse gear for releasing jammed drill bits. Can be started safely in idle position without rotating tool.

Keyed chuck available as optional accessory: 4314 680 4001



OPTIONAL CORE DRILLING KIT

Converts BT 45 into a core drill. Comes standard with 5/8" bit adapter and water attachment. Low gear reduction ratio provides significantly higher drilling speeds, ideal for concrete drilling and coring applications. Optional 1 1/4" (3.1 cm) adapter available.

Water attachment with 5/8" adapter 4314 007 1006

1 1/4" (3.1 cm) adapter 4314 682 3904

BT 131

36.3 cc • 1.4 kW • 22.0 kg ①

The increased tank capacity on the BT 131 auger's 4-MIX™ engine offers a 30% longer runtime compared to the BT 130. Equipped with quality features including a multi-functional handle, oversized hip pad, advanced vibration dampening system, STIHL Quickstop® auger brake and exhaust deflector.



① WEIGHT WITHOUT FUEL.



	Displacement (CC)	Power output	Weight (LB) ①②③	Cutting wheel (MM)	Max. cutting depth (MM)	Stratified scavenging	Anti-vibration system	Semi-automatic v-belt tensioning	Elastostart™	Decompression valve/compensator	Spindle speed (RPM), in first gear	Spindle speed (RPM), in second gear	Set parts for drilling planting holes
CUT-OFF MACHINES													
TS 410	66.7	3.2	20.7 ②	300	100	●	●	●	●	●	-	-	-
TS 420	66.7	3.2	21.2 ②	350	125	●	●	●	●	●	-	-	-
TS 440	66.7	3.2	24.5 ②	350	125	●	●	-	●	●	-	-	-
TS 500i	72.2	3.9	22.5 ②	350	125	●	●	●	●	●	-	-	-
TS 700	98.5	5.0	25.8 ②	350	125	●	●	●	●	●	-	-	-
TS 800	98.5	5.0	28.0 ②	400	145	●	●	●	●	●	-	-	-
CONCRETE CUTTER, DRILL & AUGER													
GS 461 ROCK BOSS®	76.5	4.3	16.7 ②	-	-	●	●	-	●	●	-	-	200
BT 45	27.2	0.8	16.7 ②	-	-	-	●	-	-	-	620	1,840	-
BT 131	36.3	1.4	22.0 ②	-	-	-	-	-	-	-	200	○	-

● Standard
 ○ Can be retrofitted (special accessory)
 ① Without fuel. ② Weight without fuel and cutting wheel. ③ Weight without fuel, guide bar and chain.
 Conversion Formula kW x 1.341 = bhp (ch)

Note: Specifications are as of January 1, 2024. For most recent updates, visit www.stihl.ca. Models and specifications are subject to change without notice. Manufacturer reserves the right to change appearance, function and components of any STIHL product without prior notice or liability.

GEAR UP FOR SAFETY.

116 SAFETY GEAR

117 FORESTRY APPAREL

120 SAFETY PANTS & CHAPS

124 HEAD, EYE & EAR
PROTECTION

130 PROTECTIVE HAND
& FOOTWEAR

SAFETY GEAR

SAFETY GUIDE

What to consider when choosing which type of leg protection is right for you:

WEIGHT

'PRO' leg protection is lighter in weight and features Kevlar® pads for maximum safety.

'STANDARD' leg protection is economical without sacrificing safety. Pads are constructed of a ballistic nylon/Kevlar® or Engtex blend, which is slightly heavier but still provides excellent protection.

WORKING CONDITIONS

A cotton outer fabric is more breathable and thus desirable in hot and dry conditions.

A nylon outer fabric is more moisture-resistant and will be preferable in cold and/or wet conditions.

For work in proximity to live power lines or other fire hazards, we recommend flame and hydrocarbon flash fire-resistant (FR) safety pants.

If equipment frequently changes hands or is used sporadically, chaps may be a better option.

CANADIAN SAFETY STANDARD REQUIREMENTS

ASTM F3325

CLASS 'A'

- TCS 3,000 feet per minute
- Front & back cut protection
- Back pad below knee

W.C.B.-B.C.

- TCS 3,300 feet per minute
- Front cut protection pad 1.5" below waist band with 4" extra on left side of each leg
- STIHL pant has cut protection up to waist

ENFORM

- TCS 3,300 feet per minute
- Minimum 28" long front pad with 4" extra on left side of each leg
- STIHL pant has TCS of 4,100 feet per minute
- Industry Safety Standard mandated by Energy Safety Canada

ISO 11393

European cut protection standard (Class 1) accepted from Saskatchewan eastward to New Brunswick.

TYPE A

- TCS 3,900 feet per minute
- Front cut protection (Design A)

TCS = Threshold Chain Speed

DUROFLEX RAIN JACKET

- Flexible and lightweight weatherproof jacket
- Made of waterproof, durable and easy to clean material (100% polyester with polyurethane coating)
- Functional vents on back, front and sleeves for breathability
- Integrated hood that stows neatly away in the collar
- Jacket contains 2 waterproof pockets



SIZES AVAILABLE

- S - 0088 554 0203
- M - 0088 554 0204
- L - 0088 554 0205
- XL - 0088 554 0206

RAINTEC RAIN PANTS

- Functional and breathable polyurethane outer fabric is both water and tear resistant
- "Action Arctic" material in high wear areas ensure the pants hold up under extreme conditions
- Features convenient thigh pocket and zip openings on the back of the legs



SIZES AVAILABLE

- S (32") - 0088 352 0003
- M (34") - 0088 352 0004
- L (36") - 0000 885 1056
- XL (38") - 0000 885 1060

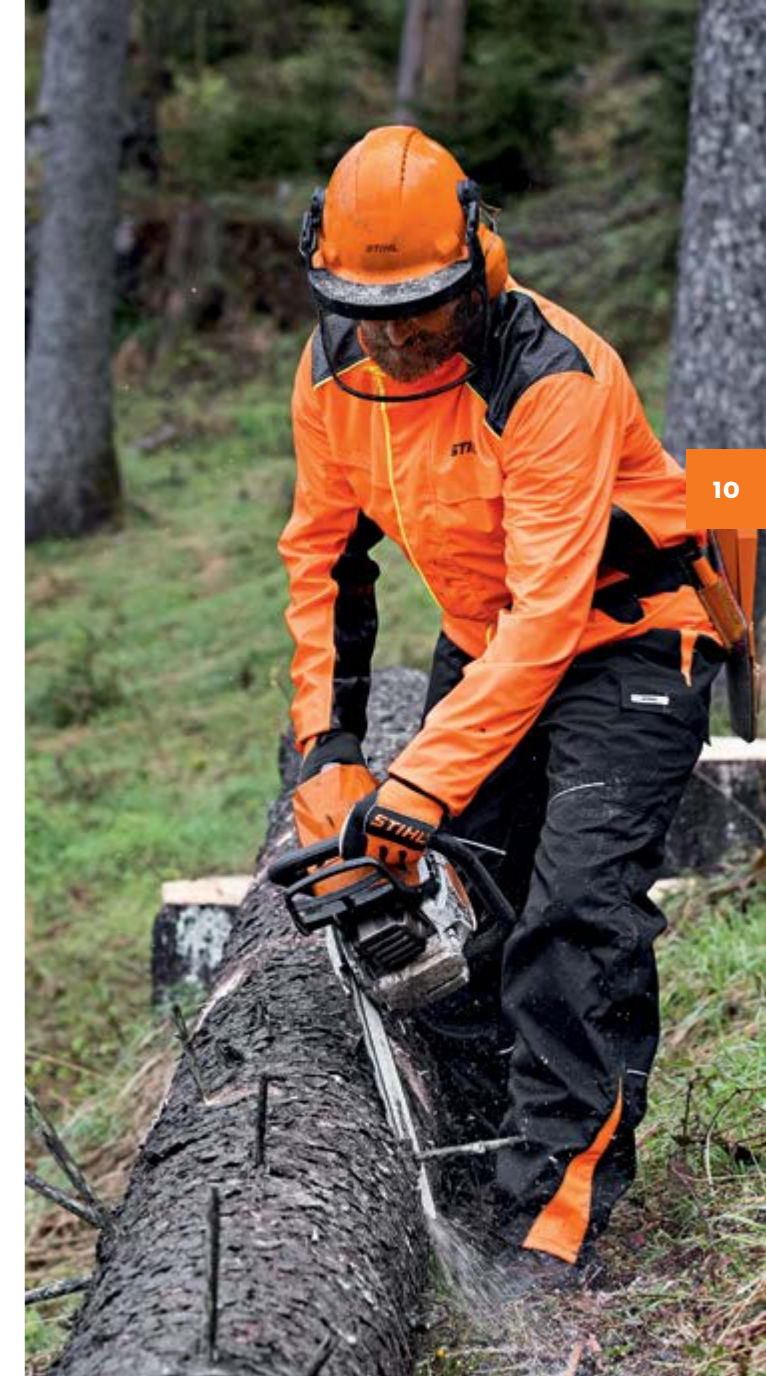

FUNCTION UNIVERSAL JACKET

- All-purpose FUNCTION Universal Jacket designed to coordinate with FUNCTION Universal Safety Pants
- "Warning" orange upper torso makes wearer more visible
- Zippered chest pocket and 2 waist pockets
- Vented under the arms
- Elbow, shoulder and collar reinforced with abrasion resistant material



SIZES AVAILABLE

- S - 0088 335 0703
- M - 0088 335 0704
- L - 0088 335 0705
- XL - 0088 335 0706
- XXL - 0088 335 0707

FUNCTION ERGO JACKET

- The STIHL FUNCTION ERGO Jacket is made of hard-wearing durable material for extended wear
- Features a high visibility orange colour and reflective strips for improved safety
- Additionally it features a large STIHL logo on the back, has elastic inserts, ventilation panels, an interior pocket, two zip pockets on the breast and reinforced elbows
- No chain saw protection



SIZES AVAILABLE

- S - 0088 335 0603
- M - 0088 335 0604
- L - 0088 335 0605
- XL - 0088 335 0606

FUNCTION UNIVERSAL SAFETY PANTS

- Poly/cotton blend, stretchable fabric with venting at back of thigh
- Seat pocket, cargo pocket and two hip pockets
- Knee and lower leg (front and back) reinforced with abrasion resistant material
- Meets EN 381-5 (ISO 11393) Standard. Class 1, Design A cut protection (equivalent to 3,900 feet per minute threshold speed)
- Cut protection on front of leg, extending from the belt line to the ankle
- Machine washable



SIZES AVAILABLE

- S (28"-31") - 0088 342 1503
- M (31"-34") - 0088 342 1504
- L (34"-38") - 0088 342 1505
- XL (38"-42") - 0088 342 1506
- XXL (42"-44") - 0088 342 1507
- XXXL (44"-46") - 0088 342 1508

FUNCTION ERGO SAFETY PANTS

- Lightweight pants comes with ventilation zips on the back of the thighs, reinforced material on the knees, versatile front and side zip pockets and elastic inserts in the inner thigh
- The FUNCTION Ergo Safety Pants are made of a hardwearing polyester/cotton material, making them both durable and extremely comfortable to wear
- Developed with the tree care professional in mind, the pants meet the EN 381, Design A (front protection), Class 1 (3,900 feet per minute), cut protection standard



SIZES AVAILABLE

- S - 0088 342 1003
- M - 0088 342 1004
- L - 0088 342 1005
- XL - 0088 342 1006
- XXL - 0088 342 1007

NEW HS/FS MULTI-PROTECT SAFETY PANTS

- The NEW HS Multi-Protect Safety Pants are made with a polyester/cotton stretch material and feature long ventilation zips on the back of the thighs for a breathable and flexible fit.
- Ideal for work with STIHL power tools (not chain saws), especially hedge trimmer (HS).
- Zip off legs changes pant length to 3/4.
- Higher back waist offers kidney protection and protects against cooling.



SIZES AVAILABLE

- XS - 0088 459 0102
- S - 0088 459 0103
- M - 0088 459 0104
- L - 0088 459 0105
- XL - 0088 459 0106
- XXL - 0088 459 0107

NEW HS 2-IN-1 PROTECTORS

Highly effective protection against cutting and pinching injuries from hedge trimmer use. Must be used in conjunction with HS/HSA Multi-Protect Safety Pants.

0000 885 2200



NEW FS LEG PROTECTORS

Breathable shin and knee protection from whirled up particles during operation of clearing saws. For insertion into the interior leg pocket.

0000 885 1801



DYNAMIC VENT PANTS

- Light and breathable deluxe safety pant that is perfectly suited for summer use
- Certified to a threshold chain speed of 3,900 feet per minute
- Zip ventilation on back of thighs and elasticated trouser back allow for comfort
- Features reinforced knees, two front pockets with zippers and mobile phone pocket
- Meets the EN 381-5 certified standard for cut protection. Class 1, Type A (front protection)



'STANDARD' 3,000 PANTS

- Certified to a threshold chain speed of 3,000 feet per minute
- 6 layers of nylon/polyester/Kevlar®
- 400 denier nylon for greater strength (nylon version)
- Front and back of leg (below knee) cut protection
- Meets ASTM F3325 standard



3,600 'PRO' PANT

- Certified to a threshold chain speed of 3,600 feet per minute
- Superior combination of protection and lightweight
- Contains 4 layers of 36" Kevlar® pads
- Outer material comprised of a 400 denier rip stop nylon
- Features chip proof pockets, high back waist, side tool pocket and 4" reflective striping
- Front cut protection
- CSA Class 2, Level 2 reflective striping
- Meets W.C.B. of B.C. cut protection standard



'STANDARD' SEISMIC PANTS

- Certified to a threshold chain speed of 4,100 feet per minute
- 5 layers of polyester/Kevlar® protective pads
- 400 denier nylon outer fabric
- Front and back of leg (below knee) cut protection
- Exceeds Enform Safety Standard



URBAN FORESTRY PANTS

- Rugged blue cotton outer features a cargo pocket on the right leg
- Reflective striping meets CSA Class 2, Level 2
- Cut protection options: 3,000 feet per minute (tested to ASTM F3325 standard) or 3,600 feet per minute (tested to W.C.B.-B.C. standard)



'DELUXE' SEISMIC PANTS

- Certified to a threshold chain speed of 4,100 feet per minute
- 5 layers of polyester/Kevlar® cut protective pads
- Black cotton outer fabric with orange reinforced knee
- Reflective striping on legs meets CSA Class 1, Level 1 standard
- Exceeds Enform Safety Standard



FLAME-RESISTANT FORESTRY PANTS

- Certified to a threshold chain speed of 3,600 feet per minute
- Westex Indura flame resistant cotton outer with glass buttons
- Reflective striping on legs meets CSA Class 2, Level 2 standard
- 4 layers polyester/Kevlar®
- Meets CAN/CGSB 155.20 (ASTM F1506) flame resistant standard, ATPV 12.4 per CSA Z46-2
- Meets ASTM F3325/W.C.B.-B.C. cut protection standard



'STANDARD' 2,600 CAMO CHAPS

- Certified to a threshold chain speed of 2,600 feet per minute
- 1,000 Denier nylon cutter's chaps
- Engtex cut resistant fabric
- Nylon/polyester (4 layers) pads
- Available in 35" overall length
- Front cut protection



'STANDARD' 2,600 CHAPS

- Designed for occasional cutting
- Certified to a threshold chain speed of 2,600 feet per minute
- Five layers of blended Engtex and nylon/polyester pads
- 400 denier nylon for greater strength
- Available in 35" overall length
- Front cut protection only



'PRO' WCB/BC 3,600 CHAPS

- Certified to a threshold chain speed of 3,600 feet per minute
- 4 layers of Kevlar® cut protective pads
- 400 denier nylon for greater strength
- Available in 38" overall length
- Front only or front/back of leg (below knee) cut protection
- Meets W.C.B. of B.C. cut protection standard



'STANDARD' 3,000 CHAPS

- Certified to a threshold chain speed of 3,000 feet per minute
- 400 denier nylon for greater strength
- Available in 35" overall length
- Front/back of leg (below knee) cut protection



'DELUXE' 4,100 CHAPS

- Certified to a threshold chain speed of 4,100 feet per minute
- 5 layers of polyester/Kevlar® protective padding
- 400 denier nylon for greater strength
- Available in 37" overall length
- Front and back of leg (below knee) cut protection
- Exceeds Enform Safety Standard



FUNCTION CHAPS

- Certified to a threshold chain speed of 3,900 feet per minute
- Ideal for chain saw applications around the house, cottage and farm
- Available in 36" and 42" length
- Form fitting knee with Y-strap arrangement for easy fastening
- Meets EN 381-5, Class 1, Type A cut protection standard



MS ARM PROTECTORS

- The MS Arm protectors are ideal for both tree care professionals and arborists to prevent cuts to the forearm and hand areas when using a chain saw or pruning tools
- Made from Engtex cut protective material
- Meets the EN 381-5 certified standard for Class 1 cut protection
- Sold by the pair

ONE SIZE
0088 544 0010

SUSPENDERS

STIHL branded suspenders
With Clips 7002 885 1500
For Buttons 7002 885 1501



Part #	Rating	Threshold chain speed (FT/MIN)	Front protection	Back protection	Cut resistant material	Colour	Fabric	Water repellent	Mesh black leg	High back	Elastic waistband	Brass buttons
PRO LEG PROTECTION (PANTS)												
DELUXE SEISMIC PANT	7002 884 0803-06	WCB/BC	4,100	●	●	Kevlar®	Black	Cotton	-	-	●	-
FUNCTION UNIVERSAL PANT	0088 342 1503-08	ISO 11393	3,900	●	-	Engtex	Black	Poly/Cotton	-	●	●	-
FUNCTION ERGO PANT	0088 342 1003-07	ISO 11393	3,900	●	-	Avertic	Multi	Poly/Cotton	-	-	●	-
DYNAMIC VENT PANT	0088 342 0903-07	ISO 11393	3,900	●	-	Avertic	Multi	Poly/Cotton	-	-	●	-
URBAN FORESTRY PANT	7002 883 2700-03	ASTM F3325	3,000	●	●	Polyester/Kevlar®	Blue	Cotton	-	-	-	-
URBAN FORESTRY PANT	7002 884 6508-11	WCB/BC	3,600	●	●	Polyester/Kevlar®	Blue	Cotton	-	-	-	-
FLAME RESISTANT FORESTRY PANT	7002 883 6528-40	ASTM F3325 WCB/BC	3,000/3,600	●	●	Polyester/Kevlar®	Blue	Cotton	-	-	-	-
3600 'PRO' PANT	7002 886 6728-40	WCB/BC	3,600	●	-	Kevlar®	Black	Nylon	-	-	●	●
PRO LEG PROTECTION (CHAPS)												
FUNCTION CHAPS	0088 521 0302-0305	ISO 11393	3,900	●	-	Avertic	Black	Poly/Cotton	-	-	-	-
3,600 CHAPS	7002 885 0805	WCB/BC	3,600	●	-	Polyester/Kevlar®	Orange	Nylon	●	-	-	-
3,600 CHAPS (EQUIPPED WITH ZIPPERS)	7002 885 0806	WCB/BC	3,600	●	●	Polyester/Kevlar®	Orange	Nylon	●	-	-	-
4,100 CHAPS (EQUIPPED WITH ZIPPERS)	7002 884 0807	ENFORM	4,100	●	●	Kevlar®	Orange	Nylon	●	-	-	-
STANDARD LEG PROTECTION (PANTS)												
2,600 PANT	7002 886 7828-44	-	2,600	●	-	Nylon/Engtex	Blue	Cotton	-	-	-	●
2,600 PANT	7002 886 7628-40	-	2,600	●	-	Nylon/Engtex	Blue	Nylon	●	●	●	●
3,000 PANT	0000 884 4600-03	ASTM F3325	3,000	●	●	Nylon/Polykevlar®	Blue	Cotton	-	-	●	●
3,000 PANT	7002 884 4628-40	ASTM F3325	3,000	●	●	Nylon/Polykevlar®	Blue	Nylon	●	●	-	●
4,100 PANT	7002 883 6101-04	ENFORM	4,100	●	●	Polyester/Kevlar®	Blue	Nylon	●	●	●	●
STANDARD LEG PROTECTION (CHAPS)												
2,600 CHAPS	7002 885 0800	-	2,600	●	-	Polyester/Engtex	Orange	Nylon	●	-	-	-
2,600 CAMO CHAPS	7002 884 0815	-	2,600	●	-	Polyester/Engtex	Camo	Nylon	●	-	-	-
3,000 CHAPS (36" VERSION)	7002 884 0802	ASTM F3325	3,000	●	●	Nylon/Kevlar®	Orange	Nylon	●	-	-	-

HEAD, EYE & EAR PROTECTION



ADVANCE VENT HELMET SYSTEM (CLASS G)

- Easy head size adjustment while wearing, using ratcheted wheel
- Comfortable six point harness
- Slim design
- Low-weight and optimized balance causing less user fatigue
- Vented helmet, NRR 25 hearing protection, etched spring steel mesh visor
- Meets both ANSI and CSA Safety Standards

Type 1, Class 'G'

7002 884 0105



ADVANCE X-VENT HELMET SYSTEM (CLASS E)

- Easy head size adjustment while wearing, using ratcheted wheel
- Comfortable six point harness
- Low-weight and optimized balance causing less user fatigue
- Non-vented helmet, NRR 25 hearing protection, etched spring steel mesh visor
- Meets both ANSI and CSA Safety Standards

Type 1, Class 'E'

7002 884 0106



ADVANCE X-VENT PROCOM HELMET SET

Combination of X-VENT helmet + ADVANCE PROCOM ear defender set

0000 888 0813



10



ADVANCE X-VENT BT SAFETY HELMET SYSTEM (CLASS E)

- Has a Bluetooth interface which allows the user to connect their smartphone or other wireless devices to the hearing protectors
- Etched metal mesh visor
- 22 NRR noise reduction rating
- Meets both CSA and ANSI Safety Standards

Type 1, Class 'E'

0000 888 0811



'A' HELMET SYSTEM (CLASS E)

- Peltor H7 Muff (NRR 24)
- Visor options: Metal mesh, brimmed (V4A)/metal mesh, brimless (V1A) /clear polycarbonate, brimmed (V4F)
- Helmet options: ANSI Type 1 or CSA Type 2

ANSI - Type 1, Class 'E'

7002 871 1444

CSA - Type 2, Class 'E'

7002 200 0066



FUNCTION BASIC HELMET SYSTEM (CLASS C)

- Lightweight and slim design
- NRR 24 hearing protection
- Nylon mesh brimmed visor

CSA - Type 1, Class 'C'

7002 888 0802



G500 FACE & HEARING PROTECTION

- Face and hearing protection combination, meets CSA Z94.3
- Adjustable ratchet harness and removable ear muffs
- Ear muff options: 'A' rated (NRR 23) or 'B' rated (NRR 21)
- Visor options: Mesh ('A' system only)

'A' Kit w/ Mesh Visor (NRR 23)

7002 888 0308

'B' Kit w/ Mesh Visor (NRR 21)

7002 888 0309

HELMET CERTIFICATION GLOSSARY

Type 1 - Top of the head protection

Type 2 - Top and side of the head protection

Class C - No shock protection

Class G - Shock protection to 2,200 V

Class E - Shock protection to 20,000 V



ARBORIST SAFETY HELMET

- Designed specifically for tree service professionals, this helmet is lightweight and features a six-point adjustable suspension for comfortable support
- Multiple vents keeps the user cool during the summer, winter liner available
- Earmuff adapter included for H6, H7, and H9 muffs
- Clear visor available

CSA - Type 1, Class 'C'

7010 883 9100



WOODCUTTER SAFETY KIT

This woodcutter safety kit is perfect for jobs around the home and farm.

KIT INCLUDES:

HIGH QUALITY SAFETY GLASSES

Polycarbonate lens with anti-fog coating and flexible temple tips.

'FUNCTION BASIC' HELMET SYSTEM (CLASS C)

Helmet system comes complete with helmet, ear muffs (NRR 24) and face shield.

CSA - Type 1, Class 'C'

WOODCUTTER CHAPS

- Designed for occasional cutting
- Certified to a threshold chain speed of 2,600 feet per minute
- 400 denier nylon for greater strength
- 35" length with front protection only

7002 200 0054



ST1000 SAFETY GLASSES

The ST1000 safety glasses are lightweight, comfortable and stylish. They feature an anti-scratch hard coated polycarbonate lens and arms that are adjustable, allowing for an outstanding, customized fit. The ST1000 glasses meet the CSA Z94.3 safety standard.

CLEAR
7002 884 0338

INDOOR/OUTDOOR
7002 884 0343

SMOKE
7002 884 0342

AMBER
7002 884 0344



ST2000 SAFETY GLASSES

The ST2000 safety glasses provide a superior combination of protection and fit. The lenses block out 99.9% of the sun's UV rays and an integrated side panel offers incredible side eye coverage. The soft nose piece allows the glasses to be comfortably worn all day. The ST2000 glasses meet the CSA Z94.3 safety standard.

CLEAR
7002 884 0339

INDOOR/OUTDOOR
7002 884 0346

SMOKE
7002 884 0345



FUNCTION SLIM SAFETY GLASSES

The Function Slim safety glasses are perfect for gardening and landscaping, use in municipalities and can be worn for recreational sport activities. They feature a large protective area due to the bent pane shape and are comfortable to wear because of their flat elastic temples and low weight. These glasses can be worn under capsule hearing protection.

SMOKE
0000 884 0378

CLEAR
0000 884 0377



ST3000 SAFETY GLASSES

The ST3000 safety glasses offer premium styling and outstanding protection. The polycarbonate high impact lenses provide 99.9% UV protection and are virtually 100% fog free for optimum user safety. Designed to exceed the needs of the most demanding user. These safety glasses are ready to work when you are. The ST3000 glasses meet the CSA Z94.3 safety standard.

SMOKE
7002 884 0340

INDOOR/OUTDOOR
7002 884 0347



GOLIATH SAFETY GLASSES

The Goliath safety glasses are suitable for a variety of different environments. With a stylish look, scratch resistant polycarbonate lenses and comfort-fit rubber temples, these safety glasses can do it all. The Goliath glasses meet the CSA Z94.3 safety standard.

WHITE FRAME/GREY MIRROR
7002 884 0341

BLACK FRAME/SILVER MIRROR
7002 884 0348

WHITE FRAME/ICE BLUE MIRROR
7002 884 0349

SMART FOREST



ACCEPT PHONE CALLS

MUTE MICROPHONE /
ACTIVATE AMBIENT
SOUND FUNCTION

MICROPHONE

VOLUME DOWN /
RADIO ON

SWITCH ON AND
OFF / MULTI-
FUNCTION BUTTON

VOLUME UP

LED STATUS

PUSH TO TALK

ADVANCE PROCOM



SMART, EFFICIENT, COMFORTABLE COMMUNICATION

With the STIHL ADVANCE ProCOM conference system, you can communicate clearly and efficiently even when working in noisy environments. Smart ear protection allows direct connections with up to 15 other headsets and a range of up to 600 m. A range of smartphone functions can also be used via Bluetooth®. ADVANCE ProCOM combines complex technology with simple control logic and extremely comfortable handling. See for yourself!



ADVANCE PROCOM EAR PROTECTORS

0000 884 0544



DYNAMIC BT EAR PROTECTORS

'A' rated headband ear protectors with Bluetooth connection (NRR 24). The slim and lightweight design allows for extended periods of use. For added safety, the user is able to make and receive phone calls while wearing. (Advance replacement BT Muffs - 0000 888 0811)

0000 884 0519



ADVANCE PROCOM EAR DEFENDER SET

0000 889 8011



HEADBAND EAR PROTECTORS

Headband ear protection available with 'A' or 'B' rating.

'A' RATED (NRR 27)

7002 888 0200

'B' RATED (NRR 25)

7002 888 0204



NEW

TIMBERSPORTS HEARING PROTECTION

- Modern TIMBERSPORTS® design in black, matt finish
- Meet CSA Safety Standards
- NRR 25 hearing protection
- Adults (250 MM), Kids (220 MM) headband length

ADULTS

0000 884 0546

KIDS

0000 884 0547

PROTECTIVE HAND & FOOTWEAR

For heavy-duty use on job sites or just working in the yard, STIHL offers premium-quality gloves and footwear for almost every outdoor task. Each pair is designed with function and durability in mind, keeping your hands and feet protected, comfortable and working at peak efficiency.



LEATHER WORK GLOVES

- Excellent dexterity and comfort
- Shirred elastic wrist to keep out debris
- Reinforced nylon palm for increased durability

M	7002 871 0755
L	7002 871 0753
XL	7002 871 0754



ADVANCE INSULATED GLOVES

- Water resistant goatskin leather palm and textile back

M	0088 611 0509
L	0088 611 0510
XL	0088 611 0511



FORESTRY CUT-RETARDANT SAFETY GLOVES

- Leather palm and synthetic textile back cut-retardant layers on back of both hands

M	0088 610 0109
L	0088 610 0110
XL	0088 610 0111



ANTI-VIBRATION GLOVES

- Padded palm
- Triple padded index finger
- Adjustable velcro wrist closure
- Breathable spandex back

S	7002 871 0766
M	7002 871 0761
L	7002 871 0762
XL	7002 871 0764
XXL	7002 871 0765



PROSCAPER LANDSCAPING GLOVES

- Premium boar skin with padded palm for maximum productivity
- Woven elastic back flexes to allow total movement freedom
- Custom fit wrist strap closure for personalized comfort

S	7002 871 0759
M	7002 871 0756
L	7002 871 0757
XL	7002 871 0758
XXL	7002 871 0760

FUNCTION SENSOTOUCH GLOVES

- High degree of dexterity and are compatible with touchscreen devices

M	0088 611 1509
L	0088 611 1510
XL	0088 611 1511



PRO PERFORMANCE GLOVES

- Premium glove made for homeowners as well as professional users
- Shock absorbing knuckles with impact protection for increased safety
- Reinforced palm for greater durability
- Velcro closure for a more secure fit
- Breathable backing for greater comfort
- No cut protection

S	7002 871 0767
M	7002 871 0768
L	7002 871 0769
XL	7002 871 0770





LAWNGRIPS® PRO PLUS SHOES

- Lightweight composite toe and puncture protection sole
- Hydry waterproof membrane
- Grip-N-Go sole provides traction and manoeuvrability
- CSA Green Patch certified
- Available in sizes 5-13, including half sizes (sizes 12 and 13 are not available in half sizes)

7002 883 3116 - 31



LAWNGRIPS® PRO 8 PLUS BOOTS

- Lightweight composite toe and puncture protection sole
- Hydry waterproof membrane
- Grip-N-Go sole provides traction and manoeuvrability
- CSA Green Patch certified
- Available in sizes 7-13, including half sizes (sizes 12 and 13 are not available in half sizes)

7002 883 3000-11



BOOT LINERS

- Not for use with leather boots

Standard (Sizes 6-15)
7002 883 1700 - 09



LIGHTWEIGHT SAFETY BOOTS



- Lightweight boots constructed of multiple layers of bonded ballistic nylon and rubber with an adjustable nylon cuff
- Meets the CSA Z195-14 protective footwear standard (Class 1 steel toe and plate, CE class 3 chain saw cut protection)

STANDARD (SIZES 6-14)
7002 884 4400 - 08

WIDE FIT (SIZES 6-14)
002 884 4108 - 16

SPIKED (SIZES 6-14)
7002 884 4409 - 17



GARDENGRIPS®

- Grip-N-Go sole provides traction and manoeuvrability
- Hydry waterproof membrane
- Premium soft PU cushion memory foam inside
- Available in sizes 4-13, including half sizes (sizes 12 and 13 are not available in half sizes)

7002 883 3148-15



NEW
LAWNGRIPS® TURF PRO BOOT

- Grip-N-Go Sole provides traction and maneuverability
- Premium soft PU cushion memory foam insole
- HyDry waterproof membrane
- CSA green patch certified
- Full grain oiled leather
- Lightweight composite toe and puncture protection sole
- Available in sizes 7-13 (sizes 12 and 13 are not available in half sizes)

7002 883 3150-61



STIHL LEATHER CHAIN SAW BOOT



- Waterproof membrane
- Ventilated, padded mesh on interior of the boot
- Speed lace system
- Meets the CSA Z195-14 protective footwear standard (Class 1 steel toe and plate, CE class 3 chain saw cut protection)
- Available in sizes 8-13

7002 886 8700-005

SPIKED RUBBER SAFETY BOOTS

- High top rubber safety boots with spiked sole
- Flexible with achilles tendon and ankle protection
- Meet the CSA Z195-14 Protective footwear standard (Class 1 steel toe and plate, CSA Green Tree chain saw protection and CE Class 3 chain saw cut protection)
- Only available in British Columbia

7002 884 3308-14



ACCESSORIZE.

136 — STIHL CONNECTED

138 — ADVANCE X-FLEX MODULAR
HARNESS SYSTEM

140 — GAS CANS, ECO-FRIENDLY
LUBRICANTS & ACCESSORIES

142 — SHARPENING ACCESSORIES

143 — CHAIN SAW ACCESSORIES

144 — HAND TOOLS &
HANDHELD SPRAYERS

146 — FELCO HAND TOOLS

148 — PROFESSIONAL,
WOODCUTTER AND
POLYAMIDE AXES

DIGITAL FLEET MANAGEMENT WITH STIHL CONNECTED

ONE SYSTEM - MANY ADVANTAGES

SAVE TIME

- ✔ **MAINTAIN OVERSIGHT**
Always have an overview of your power tool fleet
- ✔ **AUTOMATICALLY RECEIVE POWER TOOL DATA**
No more need to scan or manually make notes
- ✔ **TRACK POWER TOOL LOCATIONS**
Always know where your power tools are

PUT YOUR MIND AT EASE

- ✔ **REDUCE DOWNTIME**
Complete clarity about the condition of your power tools
- ✔ **NOTHING IMPORTANT IS FORGOTTEN**
Remember key events such as safety checks
- ✔ **OPTIMIZED INFORMATION**
Digital notes enhance transparency

SAVE MONEY

- ✔ **KEEP TRACK OF YOUR POWER TOOLS**
No more power tools left behind at the place of use
- ✔ **OPTIMIZE YOUR FLEET SIZE**
Get the facts about power tool utilisation
- ✔ **ALL INFORMATION ALWAYS ON HAND**
Move away from inefficient paper systems



SYSTEM COMPONENTS AND CONNECTIVITY

CONNECTED PRODUCTS

Connectivity for your products is the concept behind STIHL connected. Your products are connected using STIHL Smart Connector or the connectivity function already integrated into selected STIHL batteries.



STIHL CONNECTED APP

The STIHL connected app is the easy way to maintain a full overview of your power tool fleet when you're on the move, as it transmits the data on your connected products to the STIHL cloud. Available for iOS and Android.

STIHL CONNECTED BOX

As an alternative to the STIHL connected app, you can also capture data using the STIHL connected box. Installed in a central location, it forwards data about your connected products once they are within range.

STIHL CONNECTED PORTAL

The machine data saved in the STIHL cloud is then available in the STIHL connected portal for analysis and use.



BATTERIES WITH INTEGRATED CONNECTIVITY

The AR 2000 L and AR 3000 L backpack batteries and the new AP 500 S battery can also be integrated into STIHL connected and managed like a power tool: charging status, duration of use, and serial number are displayed in the STIHL connected app and in the STIHL connected portal.



SMART CONNECTOR

Smart Connector represents the basic all-purpose solution in the overall STIHL system for connecting petrol, electric, and cordless products. It is fitted to the outside of the power tool and records the machine's runtime. Data is sent to the STIHL connected app or to the STIHL connected box via Bluetooth®. Power tool information such as power tool runtime and due maintenance is then available for use in the STIHL connected app or portal. Note: The Smart Connector can also be used with power tools from other manufacturers.

Packaging unit 1 piece(s) 0000 400 4900
Packaging unit 10 piece(s) 0000 400 4903



SMART CONNECTOR 2 A

The new Smart Connector 2 A supplements the overall STIHL connected system, and is the solution for connecting selected professional cordless products of the STIHL AP-System. Smart Connector 2 A is installed at a designated position in the power tool housing and also delivers, for example, information on the speed, the power tool electronics, runtime, etc. which is then available in the STIHL connected portal. The information is then transferred in the same way as by the Smart Connector. Pressing a button shows you whether there is a message on the LED display of the power tool, regarding due maintenance for example. Detailed information is then provided in the STIHL connected app and portal.

CA01 400 4900

® Separate mobile communications contract required.

EVERYTHING AT A GLANCE WITH THE STIHL CONNECTED APP

The STIHL connected app gives you a great overview of your connected products even when you're on the move, as well as direct access to information such as battery life, last known position, and maintenance status. If a power tool develops a problem during use, you can enter a note for the workshop or get in touch with a STIHL dealer. Shortly before leaving your work site, you can use the STIHL connected app to check that you've loaded up all the power tools and haven't forgotten anything.

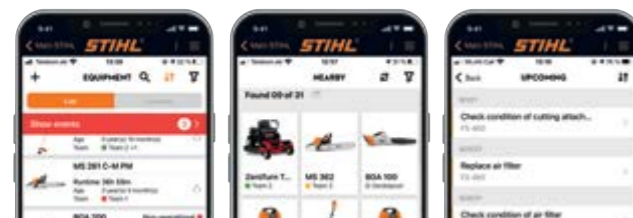

OVERVIEW

Get a complete overview of your entire power tool fleet and view the status of your machines - anytime, anywhere.

ALL PRESENT AND CORRECT

You'll always know which power tools are nearby, and you'll see immediately if anything is missing after off-site jobs.

MAINTENANCE

You'll be informed of any maintenance due, and can set maintenance deadlines directly via the app. Your own individual maintenance intervals can also be set.

DETAILED POWER TOOL INFORMATION - WITH THE STIHL CONNECTED PORTAL

The STIHL connected portal provides an easy and convenient way to digitally manage your power tool fleet, providing a constant overview while enabling you to plan your jobs efficiently and to analyze your connected products in detail. In addition, you can invite your employees, allocate them to specific teams, and individually manage access in the system as well as share access with dealers.

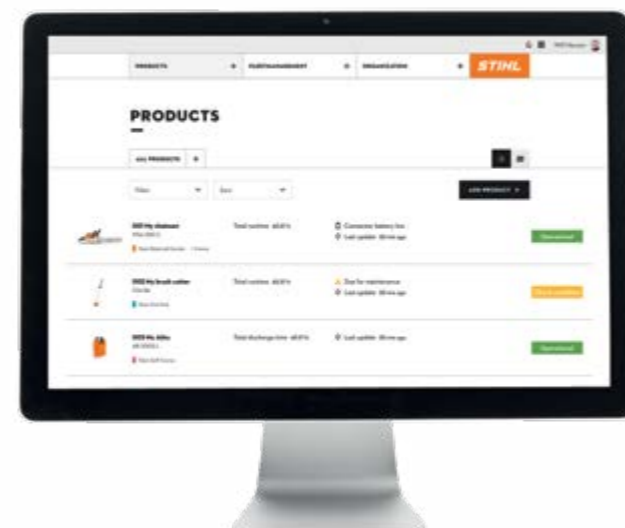

ADVANCE X-FLEX MODULAR HARNESS SYSTEM

Professionals in forestry or landscaping, and those in horticulture and public authorities, can work more efficiently with the ADVANCE X-Flex modular harness system. Thanks to practical pockets and holders as well as additional accessories that can be easily and quickly removed and attached to the harness, professionals can customize their harness to their working environment.

NEW
ADVANCE X-FLEX HIP BELT

Padded hip belt with suspension eyelets for shoulder harness and FS harness. Hip belt comes with an attachment bar for securing pockets and holders using the STIHL clip system. Stomach padding is available separately for more comfort.

- S 0000 710 9102
- M 0000 710 9103
- L 0000 710 9104



NEW
ADVANCE X-FLEX HARNESS

Slimline harness for carrying lighter loads and use in high temperatures. With suspension eyelets for the shoulder harness and attachment bar for securing pockets and holders using the STIHL clip system.

- S 0000 798 2400
- M 0000 798 2401
- L 0000 798 2402



NEW
ADVANCE X-FLEX SHOULDER HARNESS

Complements the hip harness and belt for heavy loads. Very comfortable to wear thanks to padding and adjustable harness length. It is easy to attach pockets and holders using the STIHL clip system.

0000 790 5801



NEW
UNIVERSAL POCKET

For replacement chains, marker spray, replacement chalk, a multitool, drinks and other useful items.

0000 882 6100



NEW
CHALK HOLDER

Secures chalk during transport and offers great freedom of movement while marking.

0000 881 1603



NEW
MEASURING TAPE HOLDER

Secures the measuring tape during transport and offers great unrestricted movement while measuring.

0000 881 0702



NEW
FELLING WEDGE POCKET

For two wedges of different sizes. Can each be removed independently.

0000 882 6200



NEW
SAPPIE HOLDER

Makes it easy to suspend tools by means of a snap closure.

0000 882 6300



NEW
CALLIPER HOLDER

Good freedom of movement thanks to angled securing, even with long callipers.

0000 882 6400



NEW
RADIO POCKET

Adjustable to different radios. Radio can also be operated in the pocket.

0000 882 6600



NEW
STOMACH PADDING

Can be attached to the hip harness for a more comfortable wear.

0000 490 1800



NEW
SECURING CLIPS

For attachment to pockets and holders.

0000 740 8800



NEW
SMARTPHONE POCKET

Suitable for many different smartphones. Easy removal thanks to an integrated loop.

0000 882 6700



INNOVATIVE STIHL CLIP SYSTEM

All pockets and holders in the ADVANCE X-Flex modular harness system can be easily and quickly attached to the harnesses thanks to the innovative STIHL-developed clip system, which uses metal clips. The pockets and holders come with the clips already equipped, though they can also be bought individually online. So you can even equip them to other pockets you already have, and clip them onto a harness or belt.

NO-SPILL® GAS CANS



With an easy-to-use push button nozzle, wide stable design, auto stop pouring feature and view stripes on the front and back, the No-Spill® cans are a must have for both professionals and homeowners.

5 L 7002 881 0200
10 L 7002 881 0201

GREASE GUN

Facilitates lubricating guide bar tasks.
1108 890 2500



HEAVY-DUTY GEAR LUBRICANT

For lubricating the gear box of all STIHL brushcutters and clearing saws.

40 g tube 0781 120 1022
80 g tube 0781 120 1117
225 g tube 0781 120 1118



VARIOCLEAN MULTI-CLEANER

Water based, alkaline cleaner developed to dissolve and remove organic substances like resin, oil and grass stains. Ideal for cleaning filters, chains, guide bars, cutters, saw blades and machine housings.

0782 516 8000



HEDGE TRIMMER BLADE CLEANER

Effective solvent for cleaning hedge trimmer blades and removing resin and gum build-up. Contains a lubricant which also acts as a rust inhibitor.

7002 871 1468



GAS CANS



Great value and ideal size for homeowner use. CSA/UL approved.

5 L 7002 871 0136
10 L 7002 871 0134
25 L 7002 871 0135



COMBO GAS CAN



Combo can for fuel and chain oil. CSA/UL approved.

6 L/2.5L 7002 881 0100



MULTI-PURPOSE GREASE

For lubricating the gear unit of all STIHL hedge trimmers and electric chain saws.

40 g tube 0781 120 1021
80 g tube 0781 120 1109
225 g tube 0781 120 1110



MULTIOIL BIO

Due to its biodegradable composition, STIHL Multioil Bio is ideal for all outdoor applications taking place in environmentally sensitive areas. The multifunctional oil is perfectly suited for corrosion protection, lubricating and loosening stuck parts. The 50 ml bottle is a perfect complement to the GTA 26 pruning saw.

50 ml 0782 516 8500



STIHL 2-CYCLE ENGINE OIL

STIHL 2-cycle oils are formulated to meet the high temperatures and lean running conditions of today's innovative and technically advanced STIHL engines. All STIHL 2-cycle oils contain a fuel stabilizer for longer storage life and to prevent fuel varnishing.

STIHL recommends a mix of 50:1 high-quality 89 octane unleaded gasoline to STIHL engine oil. This same mix ratio should be used during break-in.

Oil is packaged in 100 ml, 200 ml, 500 ml and 1 litre bottles (100 & 200 ml also available as a six-pack).



STIHL HP ULTRA MIX OIL - 50:1

STIHL 50:1 high-performance two-stroke synthetic oil is biodegradable in 21 days, therefore more eco-friendly. Contains fuel stabilizer and is certified to TC standard.



MOTO4PLUS

Moto4Plus is a premium alkylate fuel designed for four cycle engines. At 93 octane, this fuel contains no ethanol and is virtually free of harmful additives like benzene. Compared to petroleum based gasoline Moto4Plus offers a clean combustion which protects valves and pistons, thus improving service life. Moto4Plus is a great product for customers who operate equipment infrequently, need to store a unit over the winter, or for those customers who prefer to run a high quality fuel. The shelf life for a can of Moto4Plus is 5 years unopened and 2 years once open.

4 L can 7002 319 0005
Case of 4 x 4 L 7002 319 0006



STIHL BAR AND CHAIN OIL

STIHL bar and chain oil is formulated to adhere to the bar and chain and to reduce wear. Special agents in the oil formulation help keep sap and pitch from clinging to the bar and chain. Available in 3.79 litre bottles, in heavy, medium and light weight and 1 litre bottles in medium weight only.



STIHL BIOPLUS™ OIL

STIHL BioPlus™ eco-friendly oil is made with a vegetable oil base. Formulated to reduce the oil's impact on the environment, this biodegradable oil is an effective tool in environmentally sensitive areas, like water sheds. The oil also offers excellent flow characteristics at low temperatures and has a high flash point. Available in 3 L and 20 L containers. Rated by the Coordinating European Council to be 93.8% biodegradable in 21 days.



MOTOMIX®

MotoMix® is the ultimate choice of pre-mixed fuel for two stroke engines. It's a perfect worry-free 50:1 mix of 93 octane alkylate fuel with STIHL HP Ultra synthetic biodegradable engine oil. It will give your engine what it needs for performance and protection. With no ethanol, you don't have to worry about damaged seals or any other carburetor issues regular mixed fuel can cause.

950 ml can 7002 871 1404
Case of 6 x 950 ml 7002 871 1405
4 L can 7002 871 1469
Case of 4 x 4 L 7002 871 1470



2-IN-1 FILE HOLDER

A unique, easy-to-use filing system sharpens the cutter and lowers the depth gauge with a few simple strokes. Save time and effort with the precise accuracy of this sharpening accessory from STIHL.

.404" saw chain	0000 750 4300
3/8" P saw chain	5605 750 4303
.325" saw chain	5605 750 4304
3/8" saw chain	5605 750 4305
1/4" P saw chain	5605 750 4306



CHAIN BREAKER NG 4

For breaking saw chains.
5805 012 7500



RIVET SPINNER NG 5

For riveting saw chains.
5805 012 7510



STIHL USG

Universal sharpening tool for sharpening all STIHL saw chains, circular saw blades for FS machines and STIHL hedge trimmer blades.

Basic unit:

Complete with swivel head for all STIHL Oilomatic® saw chain and two shaped grinding wheels.

Optional:

Swivel head for hedge trimmer blades
Swivel head for circular saw blades



HEXA FILE

The Hexa file is 6-angled file patented by STIHL that provides a perfect sharpening angle (25°) which allows for faster and easier sharpening. This innovative Hexa file moves smoothly through the cutter, maintaining the proper side plate angle and also has a ridge to avoid any alignment mistakes.

5607 772 5201



DOUBLE-CUT SWISS SAW CHAIN FILES

Flat, round & square ground files. All that an experienced woodcutter needs to resharpen dull chains. Tests show that STIHL files with double-cut teeth remove material faster and last longer than other saw chain files. Available in 3-packs or by the dozen.



FLAT FILE

For lowering the depth gauges.
150 mm

Flat file for 2-in-1 0814 252 3001



FILE GUIDE

Simplify filing and help maintain correct filing angles.

1/8"	5605 750 4300
5/32"	7002 881 5901
3/16"	7002 881 5900
13/64"	7002 881 5904
7/32"	7002 881 5902



COMPLETE SHARPENING KIT

Includes file guide, depth gauge, round file, flat file and two file handles.

5/32"	7002 881 6501
3/16"	7002 881 6500
13/64"	7002 881 6504
7/32"	7002 881 6502



FILE GAUGE

For checking side and top plate cutting angles, cutter length and depth gauge setting, for cleaning the groove and oil inlet hole in the guide bar.

1/4", 3/8" PM, PM, PM3, .325", 3/8"	1110 893 4000
.404", 1/2"	1106 893 4000
1/4", .043"	0000 893 4005



12 VOLT CHAIN SHARPENER

Operates off car/truck battery and features adjustable gauge to achieve proper filing angles.

0000 882 4001



MULTI-TOOL

STIHL chain saw maintenance Multi-Tool.

For: MSE 170/MS 150/MS 193/MS 201

MT1 0000 882 6500

For: HT/HTA/MS 170-MS 880

MT2 0000 882 6501



WEDGES

STIHL offers a variety of high-impact wedges for use in felling and bucking.

8" Summer	0000 893 6802
10" Summer	0000 893 6882
12" Summer	0000 893 6884
5 1/2" Winter	7002 881 2204
8" Winter	7002 881 2201
10" Winter	7002 881 2203
10" Tri Taper	0000 893 6883



LARGE WEDGE TOOL POUCH

Wedge pouch with loop hanger and ample space for wedge and file.

Wedge & tool pouch

7002 882 5500



TOOL BELTS

Tool belts available in a variety of widths, including:

11/2" Leather	7002 883 2000
2" Leather	7002 883 2001
2" Nylon	7002 883 2002



MEASURING TAPES

Professional logging tapes made by Spencer available in 50', 65' and 75' lengths (with and without nail).

50'	7002 871 0078
65'	7002 871 0079/0115
75'	7002 871 0080/0114



FELLING LEVER

A practical tool for use in the woods. The 32" handle makes it easier to fell trees safely.

0000 881 2701



PULP HOOK

High-grade metal, pulp hook available with either a summer or winter replacement tip.

Pulp hook with summer tip

7002 881 2900

Replacement winter tip

7002 881 2901



PULP TONGS

Metal pulp tongs with non-slip grip. Maximum opening is 7.1" (18.2 cm).

0000 881 3005



KNIFE

High-quality steel blade knife with folding handle.

Single bladed knife

0464 186 0010



WOODSMAN® CARRYING CASE

Durable construction with removable bar scabbard for storing or carrying your chain saw.

Fits MS 170 to MS 391 with up to a 20" bar along with MSA models (excludes MSE, T and wrap-handle versions).

0000 900 4008



PRECISION HEDGE SHEARS

Designed for sculpting hedges, shrubs and decorative plants. Specially engineered with corrosion-resistant blades and measures 30" in length.

7010 881 3608



HAND PRUNERS

PG 10 By-Pass

Die-cast aluminum with steel blade.

0000 881 3604



PG 20 Universal By-Pass

Forged, integrally moulded plastic handles, for green wood.

Spare parts available.

0000 881 3637



PG 30 Professional By-Pass

Carbon steel blade with chrome plating for corrosion resistance. Ergonomic easy grip handles.

Spare parts available.

0000 881 3638



3-IN-1 SHARPENING TOOL

Can be used for pruning shears, knife blades and household scissors. Ergonomic design for ease of use and a professional sharpening result.

0000 881 9801



WHETSTONE

For sharpening of hand pruner, hedge shear and pruning shear blades.

0000 881 6001



PR 16 FOLDING PRUNING SAW

Pruning saw blade that is ideal when one tool has to 'do it all'. High strength steel blade with 6" cutting capacity.

Replacement blade available.

PR 16 0000 881 8700



PS 60 PRUNING SAW

For the most demanding users. 9.5" fixed blade with impulse hardened teeth. Composite sheath with thumb lock and belt loop.

7002 882 0906



PS 90 ARBORICULTURE SAW

The ultimate arborist hand saw with 12" impulse hardened blade. Sheath with thumb lock.

7002 882 0907



SUPER TURBOCUT SAW BLADE

Hard chromium-plated 16" blade ensures efficient cutting in hard and soft wood. To be used with the telescopic pole (0000 881 4113).

0000 881 4141



PR 24 & PR 32 PRUNING SAWS

Features 3-sided Japanese style teeth which are impulse hardened and chrome plated. Ergonomic handle and scabbard for left or right hand users with detachable belt loop. Replacement blades available.

PR 24 (10" / 25.4 cm)

0000 881 8701

PR 32 (13" / 33 cm)

0000 881 8702



PB 10 & PB 11 PRUNING LOPPERS

PB 10

Lightweight 23" overall length with aluminum handles and 1 1/2" cutting capacity.

0000 881 3669

PB 11

Lightweight 30" overall length with aluminum handles built with the professional in mind. 2" cutting capacity.

0000 881 3670

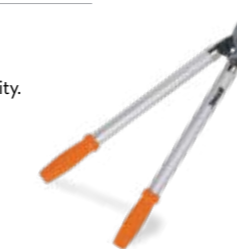

PB 30 EXTREME LOPPER

Features 33" overall length with aluminum handles and a 2" cutting capacity. Designed for the toughest jobs.

0000 881 6500



PR 27 & PR 33 PROFESSIONAL PRUNING SAWS

For quick and precise sawing. Three-sided Japanese style teeth, impulse hardened, chrome-plated steel, conical blade shape, ergonomic soft handle, corrosion-resistant, with holster for mounting on either side for operation by both left and right-handed users.

PR 27 (10.6" / 27 cm)

0000 881 8703

PR 33 (13" / 33 cm)

0000 881 8704



CANT HOOK

The STIHL Cant Hook is specially designed for gripping and moving logs in a wide range of sizes. The 48" handle features an extra-large non-slip grip for improved control and its heavy-duty body stands up to daily wear and tear. Its high-visibility orange colour is easy to spot when at the mill or on the lot.

7010 881 2602



NEW

STIHL SAPPIE / PICKAROON

For picking up and stacking firewood, small logs, and wood slices. Ash handle, German design.

0000 881 2800



PEAVEY HOOK

Perfect tool used by firewood cutters and farmers to easily manoeuvre logs. The 48" steel handle allows for excellent leverage.

7010 881 2603



POLE PRUNER PP900

The ideal tool for professional tree pruning. Durable fiberglass poles with a rope-activated pruning blade for a 4 m reach.

7002 882 0709



MID-POLE

Extends the length of the PP900 by 2 m.

0000 882 3900



TELESCOPIC POLE

For the professional arborist; lightweight and durable aluminum construction. Up to 4 m reach. Used with Super TurboCut saw blade.

0000 881 4113



SG 11

The STIHL SG 11 handheld sprayer is ideal for balconies and small gardens. It has a 1.5 L tank that delivers good working results.

4255 019 4910



SG 21

Compact 3 L manual sprayer; from the balcony garden to the backyard flower beds, the STIHL SG 21 is user friendly and versatile.

4255 019 4921



SG 31

The STIHL SG 31 is ideal for weed killing, pest and plant control and fertilizing in both homeowner and landowner applications. Professional users will also like the SG 31's compact size, 5 L tank and great features.

4255 019 4930



SG 51

Ergonomic and lightweight, the 12 L STIHL SG 51 is perfect for getting into tight spaces for precise spraying of roses and other shrubbery. Measuring the proper dosage is easy with the built-in measuring cups on the underside of the tank lid.

4255 019 4950



SG 71

The STIHL SG 71 backpack sprayer is 18 L and designed for professionals and gardening enthusiasts for spraying pesticides and disease-controlling chemicals. Built-in measuring cups on the underside of the tank lid for ease-of-use.

4255 019 4970 SG71



FELCO HAND PRUNERS

Comfort, ergonomics and durability; the marks of a quality professional tool. Long service life guaranteed, backed by an array of readily available spare parts.



F2

FELCO HAND PRUNER BASIC MODEL

• These versatile and precise basic models lend themselves to all types of work. Their straight cutting head allows right and left-handed users alike to use the tools with ease.

F2 0000 881 8500



F8



F12

FELCO HAND PRUNERS RIGHT HANDED - ERGONOMIC MODELS

These models offer cutting heads and ergonomics suited to every user, with large, medium or small hands. The tools feature inclined cutting heads to reduce physical effort and enhance user comfort. The easy cutting action can help to prevent tendonitis (RSI).

F8 0000 881 8503
F12 0000 881 8506



F9

FELCO HAND PRUNERS LEFT HANDED - ERGONOMIC MODELS

These models feature the same great qualities as above, but are designed specifically for left-handed users.

F9 0000 881 8504



PROFESSIONAL, WOODCUTTER AND POLYAMIDE AXES

WOODCUTTER AXES

With ash handles and high quality steel heads.

PROFESSIONAL AXES

Axe head made of C60 steel secured with two metal rings and a wooden wedge for maximum safety. Features a steel collar below axe head to protect wooden handle (except forestry hatchet).

POLYAMIDE AXES

Strong and durable with non-stick coating enabling smooth movement through wood. Features a fiberglass reinforced polyamide handle with an integrated C60 steel head.

PROFESSIONAL FORESTRY HATCHET

Whether you're splitting some kindling or clearing brush around a campsite, the STIHL forestry hatchet is ready for your next outdoor adventure. A handy hatchet no serious camper should be without.

Handle Material: Ash

Length: 20"
0000 881 1914



PROFESSIONAL FORESTRY AXE

For heavy-duty forestry work, you need an axe that's built to last. Its finely crafted handle will help you get into the swing of things, while its steel sleeve dramatically increases handle durability. It's the wood axe to have on-hand when felling trees, limbing, completing light splitting or driving wedges.

Handle Material: Ash

Length: 28"
0000 881 1957

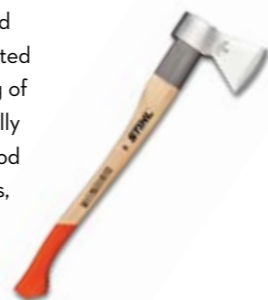

PROFESSIONAL SPLITTING AXE

Premium hickory wood handle with oversized neck. Drop forged head with precision ground edge for maximum durability. Efficient splitting head contour for exceptional productivity. Perfect for splitting large amounts of firewood.

Handle Material: Hickory

Length: 31"
0000 881 2014



PROFESSIONAL SPLITTING MAUL

Top quality hickory wood handle with oversized neck for superior strength. Drop forged head with precision ground edge for maximum durability. Efficient splitting head contour for exceptional productivity. Great for driving wedges or splitting large logs.

Handle Material: Hickory

Length: 35"
Head Weight: 6.5 LB
0000 881 2011

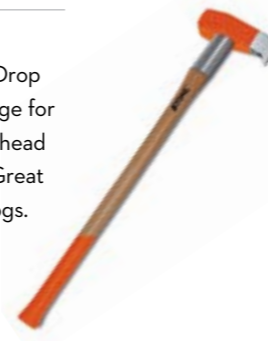

WOODCUTTER LOGGER HATCHET

This woodcutter logger hatchet features a premium ash handle and well-balanced cutting head at a slightly smaller size than the professional version. The compact design makes it the perfect choice for taking on the road for camping trips.

Handle Material: Ash

Length: 16"
0000 881 1969



WOODCUTTER FORESTRY AXE

Sometimes you just need an axe. Not a specialized felling axe, or limbing axe, or splitting maul - just a good old-fashioned swinging axe. Meet the STIHL woodcutter forestry axe. It is excellent for felling, light duty splitting, limbing and other forestry work. The handle is crafted from high-quality ash wood and the head is well balanced for a variety of cutting applications. It's the all around axe you've been looking for.

Handle Material: Ash

Length: 24"
0000 881 1971



WOODCUTTER SPLITTING MAUL

The STIHL woodcutter splitting maul features a heavy-duty cutting head that's great for driving wedges or splitting large wood. The handle is made from top quality ash and has an oversized neck for enhanced stability. It will save you time and energy when dealing with especially dense, gnarly or thick wood.

Handle Material: Ash

Length: 33"
Head Weight: 6.5 LB
0000 881 2009

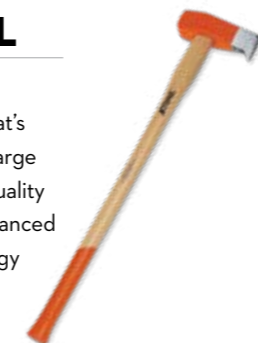

POLYAMIDE FORESTRY HATCHET

Fiberglass reinforced polyamide handles are lightweight, have a no-slip grip and are extremely strong with integrated C60 steel heads. Perfect for splitting kindling or light limbing.

Handle Material: Fiberglass/Polyamide

Length: 15"
0000 881 6801



POLYAMIDE FORESTRY AXE

Fiberglass reinforced polyamide handles are lightweight, have a no-slip grip and are extremely strong with integrated C60 steel heads. Great for light duty splitting and limbing.

Handle Material: Fiberglass/Polyamide

Length: 29"
0000 881 6701



POLYAMIDE SPLITTING MAUL

Fiberglass reinforced polyamide handles are lightweight, have a no-slip grip and are extremely strong with integrated C60 steel heads. Designed for serious wood splitting.

Handle Material: Fiberglass/Polyamide

Length: 30"
Head Weight: 4.5 LB
0000 881 6602





STIHL power tools are high-performance machines which are often subjected to extremely demanding tasks. Maintenance and care, combined with attentive customer service, play a vital role in guaranteeing the machines' operational efficiency and reliability well into the future.

YOUR STIHL SERVICING DEALER

With your STIHL Dealer, you can be sure of receiving the best possible support - for everything from advice, to sales and service. The dealership staff will advise you on the most appropriate machines for your requirements, give you useful tips on using the machine correctly and offer you professional service. This gives you the assurance that your STIHL power tool will be a pleasure to use for many years to come.

ORIGINAL STIHL PARTS

Maximum reliability, even in extreme conditions, is a hallmark of STIHL power tools. If anything should ever go wrong with your STIHL machine, the STIHL service organization has original STIHL parts in stock for you. Always use original STIHL parts to ensure maximum performance, reliability and service life from your STIHL machine. Original STIHL spare parts can be recognized by the STIHL logo or the parts symbol, a stylized S.

STIHL QUALITY CONTROL

The high standard of STIHL power tools is based on stringent quality standards, in all areas of the company. STIHL thus complies with the international ISO 9001/ISO 14001 standards for total quality and environment management. STIHL is constantly working on enhancing its entire range of machines and that is why we reserve the right to change the scope of delivery with regards to form, technology and configuration.

FOR YOUR SAFETY

If used incorrectly, all products can be a source of potential danger to the user, onlookers, animals or nearby objects. It is therefore essential to read the entire operator's manual prior to initial use and to take sufficient care when using a STIHL product, while always adhering to the safety instructions. Non-compliance could result in serious injury or death.



EXPERIENCE STIHL ONLINE



STIHLCANADA

- LIKE US ON FACEBOOK
- FOLLOW US ON TWITTER
- FOLLOW US ON INSTAGRAM
- FIND MORE INFORMATION AT STIHL.CA
- SUBSCRIBE TO OUR EMAIL NEWSLETTER
- ENTER THE WORLD OF STIHL ON YOUTUBE